

Bicycle Owner's Manual



WARNING

THIS MANUAL CONTAINS IMPORTANT SAFETY, PERFORMANCE AND SERVICE INFORMATION. Read it before you take the first ride on your new bicycle, and keep it for reference.

Register Your New GT Bike

It only takes a minute to register your bike! We stand behind everything we make, which is why we offer a limited lifetime warranty on our products.

Visit https://www.gt bicycles.com/usa_en/bike-registration to register your bike now!



Contact us

GT USA

Cycling Sports Group, Inc.
1 Cannondale Way,
Wilton CT, 06897, USA
1-800-726-BIKE (2453)
www.gt bicycles.com

CSG EUROPE

Cycling Sports Group Europe B.V.
Geeresteinselaan 57
3931JB Woudenberg
The Netherlands
service@cyclingsportsgroup.com

GT UK

Cycling Sports Group
Vantage Way, The Fulcrum,
Poole, Dorset, BH12 4NU
+44 (0)1202732288
sales@cyclingsportsgroup.co.uk

Safety Messages

In this manual, particularly important information is presented in the following ways:

WARNING

Indicates a hazardous situation which, if not avoided, may result in death or serious injury.

CAUTION

Indicates special precautions that must be taken to avoid damage.

GT SUPPORT

Our online SUPPORT contains helpful resources to consult about our bikes.



<https://support.gt bicycles.com/hc/en-us>

This manual meets: 16 CFR 1512 and EN Standards 14764, 14766, and 14781.

Vélo certifié conforme aux exigences du décret N 95-937 du 24 août 1995 norme NFR030

About This Owner's Manual

This manual contains important information affecting your safety and the proper use of bicycles. It is a very important manual for every bike we make. It is organized into three parts:

Part 1

Is a generic guide to the proper function and use of bicycles. This generic information is used by many bike companies. Most aspects of bicycles are common or "generic." PART I of this manual is the 11th edition of the generic manual.

Some Content Published Under License from the PeopleForBikes Coalition, LTD.

Part 2

Contains information specific to GT bicycles and topics we feel you need to know and understand about our bikes.

Part 3

Contains instructions on how to assemble a new bike. Please read the Warning at the beginning of this section. Please watch the assembly videos noted in this Part.

A manual alone cannot teach you how to ride or become a proficient mechanic, and a manual the size of an encyclopedia could not cover every combination of bicycle, rider and conditions.

Thus, as a reasonable person would expect, the GT manuals and supplements focus on the bicycle, not teaching you to ride.

GT Owner's Supplements

GT Owner's Manual Supplements are "supplements" to this manual providing important additional model specific safety, maintenance, and technical information. GT Owner's Manual Supplements are not replacements for this or any other manual for your bike.

You can download Adobe Acrobat PDF versions of any GT Owner's Manual or Owner's Manual Supplements or Tech Notes from our website. Go to: www.gt bicycles.com.

Authorized GT Retailer

Your local Authorized GT Retailer is your primary contact for service and adjustment of your bicycle, instruction in its use, and any warranty questions.

As noted in Part 3, If you choose to assemble a new bicycle yourself, to minimize risk, we encourage you to consider bringing your bike to a professional mechanic at a local bicycle retailer. A professional mechanic can double check the assembly and confirm your bike is ready for many miles of trouble-free riding.

To find the GT retailer closest to you, call 1-800-THE-BIKE-USA, or use our website dealer locator at www.gt bicycles.com.

Table of Contents

Part 1

General Warning 9

A Special Note for Parents 10

Section 1. First 10

- 1.A Bike Fit 11
- 1.B Safety First 11
- 1.C Mechanical Safety Check 12
- 1.D First Ride 16

Section 2. Safety. 17

- 2.A The Basics 17
- 2.B Riding Safety 18
- 2.C Off-Road Safety 20
- 2.D Wet Weather Riding 21
- 2.E Night Riding 21
- 2.F Extreme, Stunt,
or Competition Riding 23
- 2.G Changing Components
Adding Accessories 24

Section 3. Fit 25

- 3.A Stand Over Height 25
- 3.B Saddle Position 26
- 3.C Handlebar Height and Angle. 30
- 3.D Control Position Adjustments 32
- 3.E Brake Reach 32

Section 4 Bicycle Suspension.

- 4.A Wheels. 33
- 4.B Seat Post Cam Action Clamp 42
- 4.C Brakes. 27
 - Coaster Brakes 48
- 4.D Shifting Gears. 49
- 4.E Pedals 53
- 4.F Bicycle Suspension 56
- 4.G Tires and Tubes. 57

Section 5. Service 60

- 5.A Service Intervals 62
- 5.B Impact Damage 65

**Appendix A. Teaching Your
Child the Rules 66**

Part 2

**Section A.
Important Safety Information. 69**

- A Wide Range of Injuries
Are Possible 69
- Bicycles Cannot Protect You. 69
- Bicycling Inherent Risk. 70
- Warning Label 71
- Riding in Traffic, Commuting 71
- Riding at Night, Dusk, Dawn. 72-73
- Understanding E-Bikes. 74
- E-Bike Drive System ID. 75
- Operating an E-Bike 76-79
- E-Bike Batteries
and Chargers. 80-82

E-Bike Drive Maintenance 82

E-Bikes - Restricting Use 83

Required Safety Devices 83

No Modifications 84

Following Laws &
Regulations 85

Kickstands 86

Trailers 86

Racks 86

Child Carriers. 87

Distracted Attention 87

Foreign Objects 88

Be- Seen Bike Lights. 89

Maximum Fork Length 90

Rear Tire
Clearance (Full suspension). 91

Refinishing 92

Sharp Surfaces 93

Bar Ends. 93

Installing Accessories 93

Aerodynamic Handlebars 94-95

About Shimmy 95

Toe Overlap 96-97

Tire Size 97

Tire & Rim Compatibility 97

Checking Wheel Rim Wear 98

Understanding Disc
Brakes on Road Bikes 98

Brake Power Modulators 99

Aftermarket Brake Systems 100

Aftermarket Power Systems 100

Riding Off-Road 101-102

About Bicycle Suspension 102

Bicycle Reflectors 103

Carbon Fiber Seat Posts 104

Periodic Seat Post Inspection 105

Seat Post Insert Limit 106

Frame Minimum
Seat Post Insert. 108

Carbon Fiber Forks & Stems 109-114

Section B. Intended Use 115

This section also includes weight limit information.

Intended Use 116

CONDITION 1
High-Performance Road 117

CONDITION 2
General Purpose Riding 119

CONDITION 3
Cross-Country, Marathon,
Hardtails. 121

CONDITION 4
All-Mountain, Overmountain. 122

CONDITION 5
Gravity, Freeride, Downhill,
Dirt Jump 123

**Section C.
Mountain Bike Riding 125**

Off-Road Riding 125
 Bike Types 125
 Freeriding & Downhill riding 126-127
 Suspension. 128
 Jumping 128
 Stay In Control 128
 Downhill and Lift-Serviced Riding 128

**Section D.
Inspect for Safety 129**

Understanding Metals 130-136
 Understanding
 Composites(Carbon Fiber) 137-140
 Understanding Components 141-144
 Bicycle Lifespan. 144
 Useful Life of
 Light-weight Frames. 144

**Section E.
Maintenance 145**

Importance of a
 Maintenance Routine. 145
 Basics of a Good
 Maintenance Schedule 146
 Cleaning Your Bike 149
 Tightening Torques 150
 Bicycle Repair/
 Workstands 151

Section F. 152

Water Bottles. 152
 Carbon Bikes/
 Temperature Extremes. 152
 Riding Through Water 153
 Shifting Gears
 While Pedaling 153
 Bicycle Car Racks 154-156
 Using Bicycle Trainers 157
 Applying Frame Protection 158-160

Limited Warranty 216--218

Part 3 - Assembly

STEP 1.
Introduction 161

STEP 2.
Consulting Resources. 161

STEP 3.
Tools And Working Area. 162

STEP 4
Getting Your Bike Ready
For Assembly 163

STEP 5.
Installing Seatpost
And Saddle 164-166

STEP 6.
Installing Handlebar
And Stem. 167-173

STEP 7.
Bikes With Disc Brakes-
Install Rotor To Hub 174-175

STEP 8.
Install Front Wheel 176-196

STEP 9.
Front Brake Assembly
And Adjustment 196-204

STEP 10.
Install Pedals 205-207

STEP 11.
Security Checks 208-209

STEP 12.
Mountain Bike
Components And Set Up . . . 210-211

STEP 13.
Electric Bikes 212

STEP 14.
Other Types Of Bikes,
Special Components 213

STEP 15.
Final Inspection 213

STEP 16.
Test Ride And
50 Mile Tune Up 214-215

WARNING: This product contains chemicals known to the State of California to cause cancer and birth defects or other reproductive harm. (California requires this warning to be given to customers in the State of California under Proposition 65.)

PART 1

General Warning

Like any sport, bicycling involves risk of injury and damage. By choosing to ride a bicycle, you assume the responsibility for that risk, so you need to know — and to practice — the rules of safe and responsible riding and of proper use and maintenance. Proper use and maintenance of your bicycle reduces risk of injury.

This Manual contains many "Warnings" and "Cautions" concerning the consequences of failure to maintain or inspect your bicycle and of failure to follow safe cycling practices.

WARNING

The combination of the safety alert symbol  and the word WARNING (shown above) indicates a potentially hazardous situation which, if not avoided, could result in serious injury or death.

CAUTION

The combination of the safety alert symbol  and the word CAUTION (shown above) indicates a potentially hazardous situation which, if not avoided, may result in minor or moderate injury, or is an alert against unsafe practices.

CAUTION

The word CAUTION used without the safety alert symbol indicates a situation which, if not avoided, could result in serious damage to the bicycle or the voiding of your warranty.

Many of the Warnings and Cautions say "you may lose control and fall". Because any fall can result in serious injury or even death, we do not always repeat the warning of possible injury or death.

Because it is impossible to anticipate every situation or condition which can occur while riding, this Manual makes no representation about the safe use of the bicycle under all conditions. There are risks associated with the use of any bicycle which cannot be predicted or avoided, and which are the sole responsibility of the rider.

A Special Note For Parents

WARNING

This manual does not cover Juvenile or BMX bicycles.

As a parent or guardian, you are responsible for the activities and safety of your minor child, and that includes making sure that the bicycle is properly fitted to the child; that it is in good repair and safe operating condition; that you and your child have learned and understand the safe operation of the bicycle; and that you and your child have learned, understand and obey not only the applicable local motor vehicle, bicycle and traffic laws, but also the common sense rules of safe and responsible bicycling. As a parent, you should read this manual, as well as review its warnings and the bicycle's functions and operating procedures with your child, before letting your child ride the bicycle.

WARNING

Make sure that your child always wears an approved bicycle helmet when riding; but also make sure that your child understands that a bicycle helmet is for bicycling only, and must be removed when not riding.

A helmet must not be worn while playing, in play areas, on playground equipment, while climbing trees, or at any time while not riding a bicycle. Failure to follow this warning could result in serious injury or death.

Section 1. First

NOTE: We strongly urge you to read this Manual in its entirety before your first ride. At the very least, read and make sure that you understand each point in this section, and refer to the cited sections on any issue which you don't completely understand. Please note that not all bicycles have all of the features described in this manual. Ask your dealer to point out the features of your bicycle.

1.A - Bike Fit

1. Is your bike the right size? To check, see SECTION 3.A. If your bicycle is too large or too small for you, You may lose control and fall. If your new bike is not the right size, ask your dealer to exchange it before you ride it.
2. Is the saddle at the right height? To check, see SECTION 3.B. If you adjust your saddle height, follow the Minimum Insertion instructions in SECTION 3.B.
3. Are saddle and seat post securely clamped? A correctly tightened saddle will allow no saddle movement in any direction. See SECTION 3.B.
4. Are the stem and handlebars at the right height for you? If not, see SECTION 3.C.
5. Can you comfortably operate the brakes? If not, you may be able to adjust their angle and reach. See SECTION 3.D and 3.E.
6. Do you fully understand how to operate your new bicycle? If not, before your first ride, have your dealer explain any functions or features which you do not understand.

1.B - Safety First

1. Always wear an approved helmet when riding your bike, and follow the helmet manufacturer's instructions for fit, use and care.
2. Do you have all the other required and recommended safety equipment? See SECTION 2. It's your responsibility to familiarize yourself with the laws of the areas where you ride, and to comply with all applicable laws.
3. Do you know how to correctly operate your wheel quick releases? Check SECTION 4.A.1 to make sure. Riding with an improperly adjusted wheel quick release can cause the wheel to wobble or disengage from the bicycle, and cause serious injury or death.
4. If your bike has toeclips and straps or clipless ("step-in") pedals, make sure you know how they work (see SECTION 4.E). These pedals require special techniques and skills. Follow the pedal manufacturer's instructions for use, adjustment and care.

5. Do you have "toe overlap"? On smaller framed bicycles your toe or toeclip may be able to contact the front wheel when a pedal is all the way forward and the wheel is turned. Read SECTION 4.E. If you have toeclip overlap.
6. Does your bike have suspension? If so, check SECTION 4.F. Suspension can change the way a bicycle performs. Follow the suspension manufacturer's instructions for use, adjustment and care.

1.C - Mechanical Safety Check

Routinely check the condition of your bicycle before every ride.

Nuts, Bolts Screws & Other Fasteners

Because manufacturers use a wide variety of fastener sizes and shapes made in a variety of materials, often differing by model and component, the correct tightening force or torque cannot be generalized. To make sure that the many fasteners on your bicycle are correctly tightened. See page 78.

Always refer to the torque specifications in the instructions provided by the manufacturer of a component in question.

Correctly tightening a fastener requires a calibrated torque wrench.

A professional bicycle mechanic with a torque wrench should torque the fasteners on you bicycle. If you choose to work on your own bicycle, you must use a torque wrench and the correct tightening torque specifications from the bicycle or component manufacturer or from your dealer.

If you need to make an adjustment at home or in the field, we urge you to exercise care, and to have the fasteners you worked on checked by your dealer as soon as possible.

Note that there are some components which require special tools and knowledge.

In Sections 3 and 4, we discuss the items which you may be able to adjust yourself. All other adjustments and repairs should be done by a qualified bike mechanic.

 **WARNING**

Correct tightening force on fasteners –nuts, bolts, screws– on your bicycle is important.

Too little force, and the fastener may not hold securely. Too much force, and the fastener can strip threads, stretch, deform or break. Either way, incorrect tightening force can result in component failure, which can cause you to lose control and fall.

Make sure nothing is loose. Lift the front wheel off the ground by two or three inches, then let it bounce on the ground. Anything sound, feel or look loose? Do a visual and tactile inspection of the whole bike. Any loose parts or accessories? If so, secure them. If you're not sure, ask someone with experience to check.

Tires & Wheels

Make sure tires are correctly inflated (see SECTION 4.G.1). Check by putting one hand on the saddle, one on the intersection of the handlebars and stem, then bouncing your weight on the bike while looking at tire deflection. Compare what you see with how it looks when you know the tires are correctly inflated; and adjust if necessary.

Tires in good shape? Spin each wheel slowly and look for cuts in the tread and sidewall. Replace damaged tires before riding the bike.

Wheels true? Spin each wheel and check for brake clearance and side-to-side wobble. If a wheel wobbles side-to-side even slightly, or rubs against or hits the brake pads, take the bike to a qualified bike shop to have the wheel trued.

 **CAUTION**

Wheels must be true for the brakes to work effectively. Wheel truing is a skill which requires special tools and experience. Do not attempt to true a wheel unless you have the knowledge, experience and tools needed to do the job correctly.

Wheel rims clean and undamaged? Make sure the rims are clean and undamaged at the tire bead and, if you have rim brakes, along the braking surface. Check to make sure that any rim wear indicator marking is not visible at any point on the wheel rim.

 **WARNING****Bicycle wheel rims are subject to wear.**

Ask your dealer about wheel rim wear. Some wheel rims have a rim wear indicator which becomes visible as the rim's braking surface wears. A visible rim wear indicator on the side of the wheel rim is an indication that the wheel rim has reached its maximum usable life. Riding a wheel that is at the end of its usable life can result in wheel failure, which can cause you to lose control and fall.

Brakes

Check the brakes for proper operation (see SECTION 4.C). Squeeze the brake levers. Are the brake quick-releases closed? All control cables seated and securely engaged? Do the brake pads contact the wheel rim squarely and make full contact with the rim? Do the brake pads touch the wheel rim within an inch of brake lever movement?

Can you apply full braking force at the levers without having them touch the handlebar? If not, your brakes need adjustment.

Do not ride the bike until the brakes are properly adjusted by a professional bicycle mechanic.

Can you apply full braking force at the levers without having them touch the handlebar? If not, your brakes need adjustment.

Do not ride the bike until the brakes are properly adjusted by a professional bicycle mechanic.

Wheel Retention System

Make sure the front and rear wheels are correctly secured. See SECTION 4.A

Seat Post

If your seat post has an over-center cam action fastener for easy height adjustment, check that it is properly adjusted and in the locked position. See Section 4.B.

Handlebar and Saddle Alignment

Make sure the saddle and handlebar stem are parallel to the bike's center line and clamped tight enough so that you can't twist them out of alignment. See SECTION 3.B and 3.C.

Handlebar Ends

Make sure the handlebar grips are secure and in good condition. If not, have your dealer replace them. Make sure the handlebar ends and extensions are plugged. If not, plug them before you ride. If the handlebars have bar end extensions, make sure they are clamped tight enough so you can't twist them.

 **WARNING**

Loose or damaged handlebar grips or extensions can cause you to lose control and fall.

Unplugged handlebars or extensions can cut you and cause serious injury in an otherwise minor accident.

VERY IMPORTANT SAFETY NOTE:

Please also read and become thoroughly familiar with the important information on the lifespan of your bicycle and its components in PART 2, SECTION D. INSPECT FOR SAFETY.

1.D - First Ride

When you buckle on your helmet and go for your first familiarization ride on your new bicycle, be sure to pick a controlled environment, away from cars, other cyclists, obstacles or other hazards. Ride to become familiar with the controls, features and performance of your new bike.

Familiarize yourself with the braking action of the bike (see SECTION 4.C). Test the brakes at slow speed, putting your weight toward the rear and gently applying the brakes, rear brake first. Sudden or excessive application of the front brake could pitch you over the handlebars. Applying brakes too hard can lock up a wheel, which could cause you to lose control and fall. Skidding is an example of what can happen when a wheel locks up.

If your bicycle has toeclips or clipless pedals, practice getting in and out of the pedals. See paragraph B.4 above and SECTION 4.E.4.

If your bike has suspension, familiarize yourself with how the suspension responds to brake application and rider weight shifts. See paragraph B.6 above and SECTION 4.F.

Practice shifting the gears (see SECTION 4.D). Remember to never move the shifter while pedaling backward, nor pedal backwards immediately after having moved the shifter. This could jam the chain and cause serious damage to the bicycle.

Check out the handling and response of the bike; and check the comfort.

If you have any questions, or if you feel anything about the bike is not as it should be, consult your dealer before you ride again.

Section 2. Safety

WARNING

Many states require specific safety devices. It is your responsibility to familiarize yourself with the laws of the state where you ride and to comply with all applicable laws, including properly equipping yourself and your bike as the law requires.

Observe all local bicycle laws and regulations.

Observe regulations about bicycle lighting, licensing of bicycles, riding on sidewalks, laws regulating bike path and trail use, helmet laws, child carrier laws, special bicycle traffic laws.

It's your responsibility to know and obey the laws.



Figure 1. Bicycle Helmet

Your helmet should be:

- U.S. Consumer Product Safety Commission (CPSC) certified (look for the label on the helmet)
- Properly Sized for You
- Properly Fitted to You
- Properly Attached to Your Head!
- Undamaged

ASK YOUR RETAILER FOR HELP

WARNING

Failure to wear a helmet when riding may result in serious injury or death.

2.A - The Basics

1. Always wear a cycling helmet which meets the latest certification standards and is appropriate for the type of riding you do. Always follow the helmet manufacturer's instructions for fit, use and care of your helmet. Most serious bicycle injuries involve head injuries which might have been avoided if the rider had worn an appropriate helmet.

2. Always do the Mechanical Safety Check (SECTION 1.C) before you get on a bike.
3. Be thoroughly familiar with the controls of your bicycle: brakes (SECTION 4.C.); pedals (SECTION 4.E.); shifting (SECTION 4.D.)
4. Be careful to keep body parts and other objects away from the sharp teeth of chainrings, the moving chain, the turning pedals and cranks, and the spinning wheels of your bicycle.
5. Always wear:
 - Shoes that will stay on your feet and will grip the pedals. Never ride barefoot or in sandals.
 - Bright, visible clothing that is not so loose that it can be tangled in the bicycle or snagged by objects at the side of the road or trail.
 - Protective eye wear, to protect against airborne dirt, dust and bugs —tinted when the sun is bright, clear when it's not.
6. Unless your bicycle was specifically designed for jumping, don't jump with your bike. Jumping a bike, particularly a BMX or mountain bike, can be fun; but it can put huge and unpredictable stress on the bicycle and its components. Riders who insist on jumping their bikes risk serious damage, to their bicycles as well as to themselves. Before you attempt to jump, do stunt riding or race with your bike, read and understand SECTION 2.F.

7. Ride at a speed appropriate for conditions. Increased speed means higher risk.

2.B - Riding Safety

1. Obey all rules of the road and all local traffic laws.
2. You are sharing the road or the path with others — motorists, pedestrians and other cyclists. Respect their rights.
3. Ride defensively. Always assume that others do not see you.
4. Look ahead, and be ready to avoid:
 - Vehicles slowing or turning, entering the road or your lane ahead of you, or coming up behind you.
 - Parked car doors opening.
 - Pedestrians stepping out. • Children or pets playing near the road.
 - Pot holes, sewer grating, railroad tracks, expansion joints, road or sidewalk construction, debris and other obstructions that could cause you to swerve into traffic, catch your wheel or otherwise cause you to lose control and have an accident.
 - The many other hazards and distractions which can occur on a bicycle ride.

5. Ride in designated bike lanes, on designated bike paths or as close to the edge of the road as possible, in the direction of traffic flow or as directed by local governing laws.
6. Stop at stop signs and traffic lights; slow down and look both ways at street intersections. Remember that a bicycle always loses in a collision with a motor vehicle, so be prepared to yield even if you have the right of way.
7. Use approved hand signals for turning and stopping.
8. Never ride with headphones. They mask traffic sounds and emergency vehicle sirens, distract you from concentrating on what's going on around you, and their wires can tangle in the moving parts of the bicycle, causing you to lose control.
9. Never carry a passenger, and before installing a child carrier or trailer, check with you dealer or the bicycle manufacturer to make sure the bicycle is designed for it. If the bicycle is suitable for a child carrier or trailer, make sure that the carrier or trailer is correctly mounted and the child secured and wearing an approved and properly fitted helmet.
10. Never carry anything which obstructs your vision or your complete control of the bicycle, or which could become entangled in the moving parts of the bicycle.
11. Never hitch a ride by holding on to another vehicle.
12. Don't do stunts, wheelies or jumps. If you intend to do stunts, wheelies, jumps or go racing with your bike despite our advice not to, read SECTION 2.F, Downhill, Stunt or Competition Biking, now. Think carefully about your skills before deciding to take the large risks that go with this kind of riding.
13. Don't weave through traffic or make any moves that may surprise people with whom you are sharing the road.
14. Observe and yield the right of way.
15. Never ride your bicycle while under the influence of alcohol or drugs.
16. If possible, avoid riding in bad weather, when visibility is obscured, at dawn, dusk or in the dark, or when extremely tired. Each of these conditions increases the risk of accident.

2.C - Off-Road Safety

We recommend that children not ride on rough terrain unless they are accompanied by an adult.

1. The variable conditions and hazards of off-road riding require close attention and specific skills. Start slowly on easier terrain and build up your skills. If your bike has suspension, the increased speed you may develop also increases your risk of losing control and falling. Get to know how to handle your bike safely before trying increased speed or more difficult terrain.
2. Wear safety gear appropriate to the kind of riding you plan to do.
3. Don't ride alone in remote areas. Even when riding with others, make sure that someone knows where you're going and when you expect to be back.
4. Always take along some kind of identification, so that people know who you are in case of an accident; and take along a couple of dollars in cash for a candy bar, a cool drink or an emergency phone call.
5. Yield right of way to pedestrians and animals. Ride in a way that does not frighten or endanger them, and give them enough room so that their unexpected moves don't endanger you.

6. Be prepared. If something goes wrong while you're riding off-road, help may not be close.
7. Before you attempt to jump, do stunt riding or race with your bike, read and understand SECTION 2.F.

Off-Road Respect

Obey the local laws regulating where and how you can ride off-road, and respect private property. You may be sharing the trail with others — hikers, equestrians, other cyclists. Respect their rights. Stay on the designated trail. Don't contribute to erosion by riding in mud or with unnecessary sliding. Don't disturb the ecosystem by cutting your own trail or shortcut through vegetation or streams. It is your responsibility to minimize your impact on the environment. Leave things as you found them; and always take out everything you brought in.

2.D - Wet Weather Riding

Under wet conditions, the stopping power of your brakes (as well as the brakes of other vehicles sharing the road) is dramatically reduced and your tires don't grip nearly as well. This makes it harder to control speed and easier to lose control.

WARNING

Wet weather impairs traction, braking and visibility, both for the bicyclist and for other vehicles sharing the road.

The risk of an accident is dramatically increased in wet conditions.

To make sure that you can slow down and stop safely in wet conditions, ride more slowly and apply your brakes earlier and more gradually than you would under normal, dry conditions. See also SECTION 4.C.

2.E - Night Riding

Riding a bicycle at night is much more dangerous than riding during the day. A bicyclist is very difficult for motorists and pedestrians to see. Therefore, children should never ride at dawn, at dusk or at night. Adults who chose to accept the greatly increased risk of riding at dawn, at dusk or at night need to take extra care both riding and choosing specialized equipment which helps reduce that risk. Consult your dealer about night riding safety equipment.

WARNING

Reflectors are not a substitute for required lights. Riding at dawn, at dusk, at night or at other times of poor visibility without an adequate bicycle lighting system and without reflectors is dangerous and may result in serious injury or death.

Bicycle reflectors are designed to pick up and reflect street lights and car lights in a way that may help you to be seen and recognized as a moving bicyclist.

CAUTION

Check reflectors and their mounting brackets regularly to make sure that they are clean, straight, unbroken and securely mounted. Have your dealer replace damaged reflectors and straighten or tighten any that are bent or loose.

The mounting brackets of front and rear reflectors are often designed as brake straddle cable safety catches which prevent the straddle cable from catching on the tire tread if the cable jumps out of its yoke or breaks.

WARNING

Do not remove the front or rear reflectors or reflector brackets from your bicycle.

They are an integral part of the bicycle's safety system.

Removing the reflectors may reduce your visibility to others using the roadway. Being struck by other vehicles may result in serious injury or death.

The reflector brackets may protect you from the brake straddle cable catching on the tire in the event of brake cable failure. If a brake straddle cable catches on the tire, it can cause the wheel to stop suddenly, causing you to lose control and fall.

If you choose to ride under conditions of poor visibility, check and be sure you comply with all local laws about night riding, and take the following strongly recommended additional precautions:

- Purchase and install battery or generator powered head and tail lights which meet all regulatory requirements and provide adequate visibility.
- Wear light colored, reflective clothing and accessories, such as a reflective vest, reflective arm and leg bands, reflective stripes on your helmet, flashing lights attached to your body and/or your bicycle ... any reflective device or light source that moves will help you get the attention of approaching motorists, pedestrians and other traffic.
- Make sure your clothing or anything you may be carrying on the bicycle does not obstruct a reflector or light.
- Make sure that your bicycle is equipped with correctly positioned and securely mounted reflectors.

WHILE RIDING AT DAWN, AT DUSK OR AT NIGHT:

- Ride slowly.
- Avoid dark areas and areas of heavy or fast-moving traffic.
- Avoid road hazards.
- If possible, ride on familiar routes.

IF RIDING IN TRAFFIC:

- Be predictable. Ride so that drivers can see you and predict your movements.
- Be alert. Ride defensively and expect the unexpected.
- If you plan to ride in traffic often, ask your dealer about traffic safety classes or a good book on bicycle traffic safety.

2.F - Extreme, Stunt Or Competition Riding

Whether you call it Aggro, Hucking, Freeride, North Shore, Downhill, Jumping, Stunt Riding, Racing or something else: if you engage in this sort of extreme, aggressive riding you will get hurt, and you voluntarily assume a greatly increased risk of injury or death.

Not all bicycles are designed for these types of riding, and those that are may not be suitable for all types of aggressive riding. Check with your dealer or the bicycle's manufacturer about the suitability of your bicycle before engaging in extreme riding.

When riding fast down hill, you can reach speeds achieved by motorcycles, and therefore face similar hazards and risks. Have your bicycle and equipment carefully inspected by a qualified mechanic and be sure it is in perfect condition. Consult with expert riders and race officials on conditions and equipment advisable at the site where you plan to ride. Wear appropriate safety gear, including an approved full face helmet, full finger gloves, and body armor. Ultimately, it is your responsibility to have proper equipment and to be familiar with course conditions.

WARNING

Although many catalogs, advertisements and articles about bicycling depict riders engaged in extreme riding, this activity is extremely dangerous, increases your risk of injury or death, and increases the severity of any injury.

Remember that the action depicted is being performed by professionals with many years of training and experience.

Know your limits and always wear a helmet and other appropriate safety gear. Even with state-of-the-art protective safety gear, you could be seriously injured or killed when jumping, stunt riding, riding downhill at speed or in competition.

WARNING

Bicycles and bicycle parts have limitations with regard to strength and integrity, and this type of riding can exceed those limitations or dramatically reduce the length of their safe use.

We recommend against this type of riding because of the increased risks; but if you choose to take the risk, at least:

- Take lessons from a competent instructor first
- Start with easy learning exercises and slowly develop your skills before trying more difficult or dangerous riding.
- Use only designated areas for stunts, jumping, racing or fast downhill riding
- Wear a full face helmet, safety pads and other safety gear.
- Understand and recognize that the stresses imposed on your bike by this kind of activity may break or damage parts of the bicycle and void the warranty.
- Take your bicycle to your dealer if anything breaks or bends. Do not ride your bicycle when any part is damaged.

If you ride downhill at speed, do stunt riding or ride in competition, know the limits of your skill and experience. Ultimately, avoiding injury is your responsibility.

2.G - Changing Components Or Adding Accessories

There are many components and accessories available to enhance the comfort, performance and appearance of your bicycle. However, if you change components or add accessories, you do so at your own risk. The bicycle's manufacturer may not have tested that component or accessory for compatibility, reliability or safety on your bicycle.

Before installing any component or accessory, including a different size tire, make sure that it is compatible with your bicycle by checking with your dealer.

Be sure to read, understand and follow the instructions that accompany the products you purchase for your bicycle. See also PART II, SECTION D. INSPECT FOR SAFETY.

Be sure to read, understand and follow the instructions that accompany the products you purchase for your bicycle. See also PART II, SECTION D. INSPECT FOR SAFETY.

(continued, next page...)

 **WARNING**

Failure to confirm compatibility, properly install, operate and maintain any component or accessory can result in serious injury or death.

 **WARNING**

Exposed springs on the saddle of any bicycle fitted with a child seat can cause serious injury to the child.

 **WARNING**

Changing the components on your bike with other than genuine replacement parts compromise the safety of your bicycle and may void the warranty. Check with your dealer before changing the components on your bike.

Section 3. Fit

NOTE: Correct fit is an essential element of bicycling safety, performance and comfort. Making the adjustments to your bicycle which result in correct fit for your body and riding conditions requires experience, skill and special tools. Always have your dealer make the adjustments on your bicycle; or, if you have the experience, skill and tools, have your dealer check your work before riding.

 **WARNING**

If your bicycle does not fit properly, you may lose control and fall.

If your new bike doesn't fit, ask your dealer to exchange it before you ride it.

3.A - Stand Over Height

1. Diamond frame bicycles

Stand over height is the basic element of bike fit (see fig. 2). It is the distance from the ground to the top of the bicycle's frame at that point where your crotch is when straddling the bike.

To check for correct stand over height, straddle the bike while wearing the kind of shoes in which you'll be riding, and bounce vigorously on your heels.

If your crotch touches the frame, the bike is too big for you. Don't even ride the bike around the block. A bike which you ride only on paved surfaces and never take off-road should give you a minimum stand over height clearance of two inches (5 cm). A bike that you'll ride on unpaved surfaces should give you a minimum of three inches (7.5 cm) of stand over height clearance. And a bike that you'll use off road should give you four inches (10 cm) or more of clearance.



Figure 2. Stand Over Height

WARNING

If you plan to use your bike for jumping or stunt riding, read Section 2.F again.

2. Step-through frame bicycles

Standover height does not apply to bicycles with step-through frames. Instead, the limiting dimension is determined by saddle height range. You must be able to adjust your saddle position as described in 3.B. SADDLE POSITION without exceeding the limits set by the height of the top of the seat tube and the "Minimum Insertion" or "Maximum Extension" mark on the seat post.

3.B - Saddle Position

Correct saddle adjustment is an important factor in getting the most performance and comfort from your bicycle. If the saddle position is not comfortable for you, see your dealer.

The saddle can be adjusted in three directions:

1. Up and Down Adjustment

To check for correct saddle height (fig. 3):

- Sit on the saddle;
- Place one heel on a pedal;
- Rotate the crank until the pedal with your heel on it is in the down position and the crank arm is parallel to the seat tube.

If your leg is not completely straight, your saddle height needs to be adjusted. If your hips must rock for the heel to reach the pedal, the saddle is too high. If your leg is bent at the knee with your heel on the pedal, the saddle is too low.

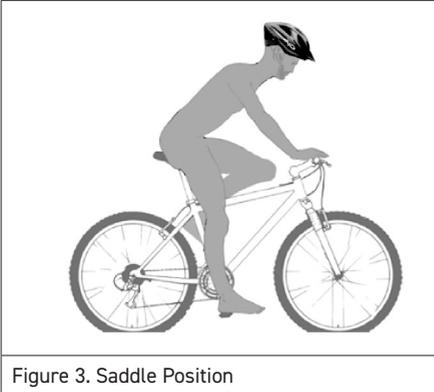

Figure 3. Saddle Position

Ask your dealer to set the saddle for your optimal riding position and to show you how to make this adjustment. If you choose to make your own saddle height adjustment:

- loosen the seat post clamp
- raise or lower the seat post in the seat tube
- make sure the saddle is straight fore and aft
- re-tighten the seat post clamp to the recommended torque (See manufacturer's instructions).

Once the saddle is at the correct height, make sure that the seat post does not project from the frame beyond its "Minimum Insertion" or "Maximum Extension" mark (fig. 4).

NOTE: Some bicycles have a sight hole in the seat tube, the purpose of which is to make it easy to see whether the seat post is inserted in the seat tube far enough to be safe. If your bicycle has such a sight hole, use it instead of the "Minimum Insertion" or "Maximum Extension" mark to make sure the seat post is inserted in the seat tube far enough to be visible through the sight hole.

If your bike has an interrupted seat tube, as is the case on some suspension bikes, you must also make sure that the seat post is far enough into the frame so that you can touch it through the bottom of the interrupted seat tube with the tip of your finger without inserting your finger beyond its first knuckle. Also see NOTE above and fig. 5).

WARNING

If your seat post is not inserted in the seat tube as described in B.1 above, the seat post may break, which could cause you to lose control and fall.

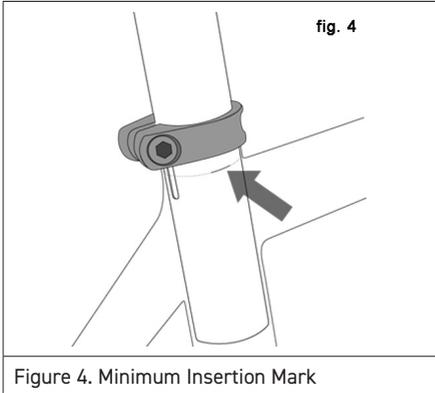

Figure 4. Minimum Insertion Mark

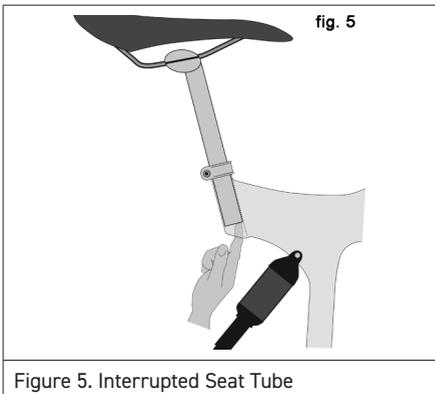

Figure 5. Interrupted Seat Tube

If you choose to make your own front and back adjustment, make sure that the clamp mechanism is clamping on the straight part of the saddle rails and is not touching the curved part of the rails, and that you are using the recommended torque on the clamping fastener(s) (See manufacturer's instructions).

3. Saddle Angle Adjustment

Most people prefer a horizontal saddle; but some riders like the saddle nose angled up or down just a little. Your dealer can adjust saddle angle or teach you how to do it.

If you choose to make your own saddle angle adjustment and you have a single bolt saddle clamp on your seat post, it is critical that you loosen the clamp bolt sufficiently to allow any serrations on the mechanism to disengage before changing the saddle's angle, and then that the serrations fully re-engage before you tighten the clamp bolt to the recommended torque (See manufacturer's instructions).

2. Front and Back Adjustment

The saddle can be adjusted forward or back to help you get the optimal position on the bike. Ask your dealer to set the saddle for your optimal riding position and to show you how to make this adjustment.

 **WARNING**

When making saddle angle adjustments with a single bolt saddle clamp, always check to make sure that the serrations on the mating surfaces of the clamp are not worn. Worn serrations on the clamp can allow the saddle to move, causing you to lose control and fall.

Always tighten fasteners to the correct torque. Bolts that are too tight can stretch and deform. Bolts that are too loose can move and fatigue. Either mistake can lead to a sudden failure of the bolt, causing you to lose control and fall.

NOTE: If your bicycle is equipped with a suspension seat post, periodically ask your dealer to check it. Ask your dealer for recommended service intervals for your suspension seat post.

Small changes in saddle position can have a substantial effect on performance and comfort. To find your best saddle position, make only one adjustment at a time.

 **WARNING**

After any saddle adjustment, be sure that the saddle adjusting mechanism is properly tightened before riding. A loose saddle clamp or seat post binder can cause damage to the seat post, or can cause you to lose control and fall.

A correctly tightened saddle adjusting mechanism will allow no saddle movement in any direction. Periodically check to make sure that the saddle adjusting mechanism is properly tightened.

If, in spite of carefully adjusting the saddle height, tilt and fore-and-aft position, your saddle is still uncomfortable, you may need a different saddle design. Saddles, like people, come in many different shapes, sizes and resilience. Your dealer can help you select a saddle which, when correctly adjusted for your body and riding style, will be comfortable.

 **WARNING**

Some people have claimed that extended riding with a saddle which is incorrectly adjusted or which does not support your pelvic area correctly can cause short-term or long-term injury to nerves and blood vessels, or even impotence.

If your saddle causes you pain, numbness or other discomfort, listen to your body and stop riding until you see your dealer about saddle adjustment or a different saddle.

3.C - Handlebar Height And Angle

Your bike is equipped either with a “threadless” stem, which clamps on to the outside of the steerer tube, or with a “quill” stem, which clamps inside the steerer tube by way of an expanding binder bolt. If you aren't absolutely sure which type of stem your bike has, ask your dealer.

If your bike has a “threadless” stem (fig 6), your dealer may be able to change handlebar height by moving height adjustment spacers from below the stem to above the stem, or vice versa. Otherwise, you'll have to get a stem of different length or rise. Consult your dealer. Do not attempt to do this yourself, as it requires special knowledge.

If your bike has a “quill” stem (fig 7), you can ask your dealer to adjust the handlebar height a bit by adjusting stem height.

A quill stem has an etched or stamped mark on its shaft which designates the stem's “Minimum Insertion” or “Maximum Extension”. This mark must not be visible above the headset.

WARNING

A quill stem's “minimum insertion mark” must not be visible above the top of the headset.

If the stem is extended beyond the minimum insertion mark the stem may break or damage the fork's steerer tube, which could cause you to lose control and fall.

FIGURE 6

THREADLESS

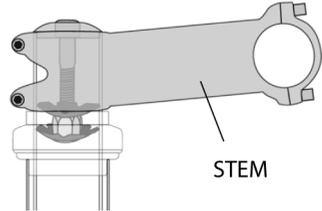
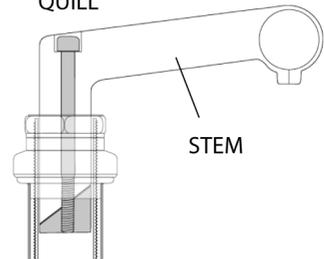

FIGURE 7

QUILL



Figures.

 **WARNING**

On some bicycles, changing the stem or stem height can affect the tension of the front brake cable, locking the front brake or creating excess cable slack which can make the front brake inoperable. If the front brake pads move in towards the wheel rim or out away from the wheel rim when the stem or stem height is changed, the brakes must be correctly adjusted before you ride the bicycle.

Some bicycles are equipped with an adjustable angle stem. If your bicycle has an adjustable angle stem, ask your dealer to show you how to adjust it. Do not attempt to make the adjustment yourself, as changing stem angle may also require adjustments to the bicycle's controls.

 **WARNING**

Always tighten fasteners to the correct torque.

Bolts that are too tight can stretch and deform. Bolts that are too loose can move and fatigue. Either mistake can lead to a sudden failure of the bolt, causing you to lose control and fall.

Your dealer can also change the angle of the handlebar or bar end extensions.

 **WARNING**

An insufficiently tightened stem binder bolt, handlebar binder bolt or bar end extension clamping bolt may compromise steering action, which could cause you to lose control and fall.

Place the front wheel of the bicycle between your legs and attempt to twist the handlebar/stem assembly. If you can twist the stem in relation to the front wheel, turn the handlebars in relation to the stem, or turn the bar end extensions in relation to the handlebar, the bolts are insufficiently tightened.

 **WARNING**

Be aware that adding aerodynamic extensions to handlebars will change the steering and braking response of the bicycle.

3.D - Control Position Adjustments

The angle of the brake and shift control levers and their position on the handlebars can be changed. Ask your dealer to make the adjustments for you.

If you choose to make your own control lever angle adjustment, be sure to re-tighten the clamp fasteners to the recommended torque (See manufacturer's instructions).

3.E - Brake Reach

Many bikes have brake levers which can be adjusted for reach. If you have small hands or find it difficult to squeeze the brake levers, your dealer can either adjust the reach or fit shorter reach brake levers.

 **WARNING**

The shorter the brake lever reach, the more critical it is to have correctly adjusted brakes, so that full braking power can be applied within available brake lever travel.

Brake lever travel insufficient to apply full braking power can result in loss of control, which may result in serious injury or death.

Section 4. Tech

It's important to your safety, performance and enjoyment to understand how things work on your bicycle.

We urge you to ask your dealer how to do the things described in this section before you attempt them yourself, and that you have your dealer check your work before you ride the bike.

If you have even the slightest doubt as to whether you understand something in this section of the Manual, talk to your dealer.

See also:

- PART I "Coaster Brakes"
- PART II, SECTION B., INTENDED USE
- PART II, SECTION D., INSPECT FOR SAFETY
- PART II, SECTION E., MAINTENANCE

4.A - Wheels

Bicycle wheels are designed to be removable for easier transportation and for repair of a tire puncture. In most cases, the wheel axles are inserted into slots, called "dropouts" in the fork and frame, but some suspension mountain bikes use what is called a "through axle" wheel mounting system.

If you have a mountain bike equipped with through axle front or rear wheels, make sure that your dealer has given you the manufacturer's instructions, and follow those when installing or removing a through axle wheel. If you don't know what a through axle is, ask your dealer.

If you do not have a bicycle with a through-axle mounting system, it will have wheel secured in one of the following three ways:

- A hollow axle with a shaft ("skewer") running through it which has an adjustable tension nut on one end and an over-center cam on the other (cam action system, fig.8a & 8b).
- A hollow axle with a shaft ("skewer") running through it which has a nut on one end and a fitting for a hex key, lock lever or other tightening device on the other (through bolt, fig. 9)
- Hex nuts or hex key bolts which are threaded on to or into the hub axle (bolt-on wheel, fig. 10)

WARNING

Riding with an improperly secured wheel can allow the wheel to wobble or fall off the bicycle, **or suddenly stop the wheel**, which can cause serious injury or death. Therefore, it is essential that you:

1. Ask your dealer to help you make sure you know how to install and remove your wheels safely.
2. Understand and apply the correct technique for clamping your wheel in place.
3. Each time, before you ride the bike, check that the wheel is securely clamped. The clamping action of a correctly secured wheel must emboss the surfaces of the dropouts.

continued next page...

continued from previous page...

Some bicycles are equipped with a quick release lever and a disc brake. If the bicycle is ridden with the lever incorrectly adjusted or open, and the lever contacts the disc or wheel (next figure), the front wheel could stop suddenly, causing the rider to fall. Always make sure your wheels are correctly attached, and the attachment mechanisms closed and locked, before riding the bicycle.

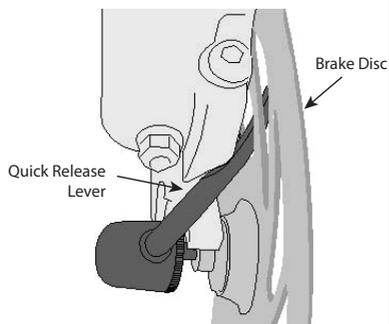

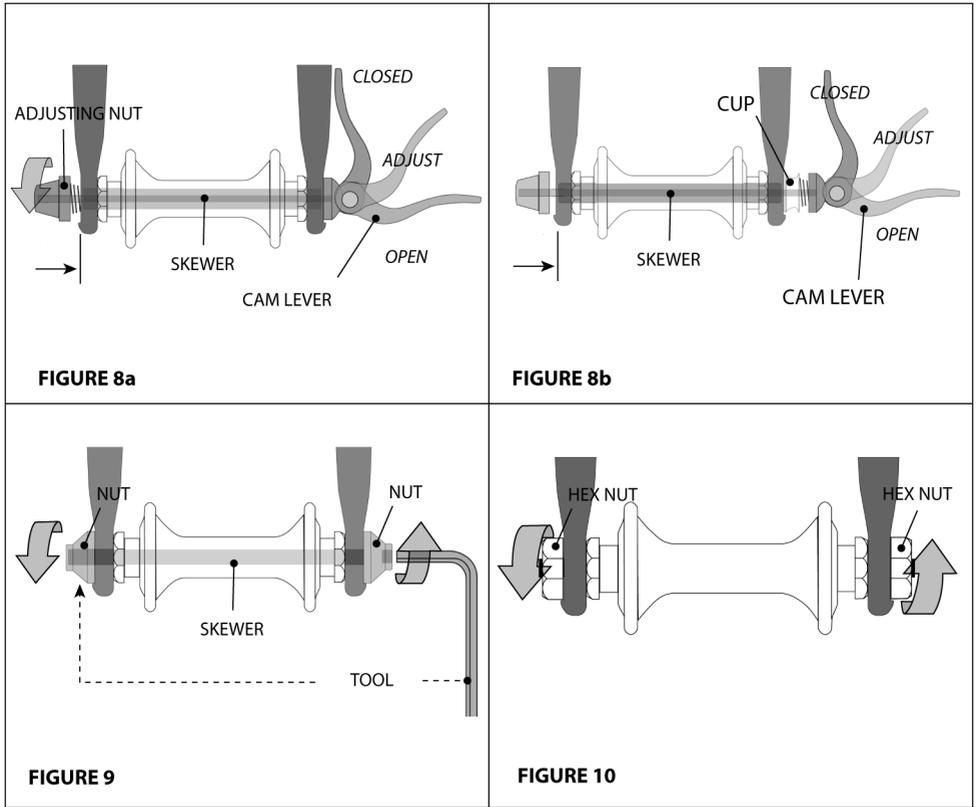

Your bicycle may be equipped with a different securing method for the front wheel than for the rear wheel. Discuss the wheel securing method for your bicycle with your dealer.

It is very important that you understand the type of wheel securing method on your bicycle, that you know how to secure the wheels correctly, and that you know how to apply the correct clamping force that safely secures the wheel.

Ask your dealer to instruct you in correct wheel removal and installation, and ask for the manufacturer's instructions.

1. Front Wheel Secondary Retention Devices

Most bicycles have front forks which utilize a secondary wheel retention device to reduce the risk of the wheel disengaging from the fork if the wheel is incorrectly secured. Secondary retention devices are not a substitute for correctly securing your front wheel.

Secondary retention devices fall into two basic categories:

- a. The clip-on type is a part which the manufacturer adds to the front wheel hub or front fork.
- b. The integral type is molded, cast or machined into the outer faces of the front fork dropouts.

Ask your dealer to explain the particular secondary retention device on your bike.

WARNING

Do not remove or disable the secondary retention device.

As its name implies, it serves as a back-up for a critical adjustment. If the wheel is not secured correctly, the secondary retention device can reduce the risk of the wheel disengaging from the fork. Removing or disabling the secondary retention device may also void the warranty.

Secondary retention devices are not a substitute for correctly securing your wheel. Failure to properly secure the wheel can cause the wheel to wobble or disengage, which could cause you to lose control and fall, resulting in serious injury or death.

2. Wheels with cam action systems

There are currently two types of over-center cam wheel retention mechanisms: the traditional over-center cam (fig. 8a) and the cam-and-cup system (fig. 8b). Both use an over-center cam action to clamp the bike's wheel in place. Your bicycle may have a cam-and-cup front wheel retention system and a traditional rear wheel cam action system.

a. Adjusting the traditional cam action mechanism (fig. 8a)

The wheel hub is clamped in place by the force of the over-center cam pushing against one dropout and pulling the tension adjusting nut, by way of the skewer, against the other dropout. The amount of clamping force is controlled by the tension adjusting nut. Turning the tension adjusting nut clockwise while keeping the cam lever from rotating increases clamping force; turning it counterclockwise while keeping the cam lever from rotating reduces clamping force. Less than half a turn of the tension adjusting nut can make the difference between safe clamping force and unsafe clamping force.

WARNING

The full force of the cam action is needed to clamp the wheel securely.

Holding the nut with one hand and turning the lever like a wing nut with the other hand until everything is as tight as you can get it will not clamp a cam action wheel safely in the dropouts.

See also WARNING on page 33.

b. Adjusting the cam-and-cup mechanism (fig. 8B)

The cam-and-cup system on your front wheel will have been correctly adjusted for your bicycle by your dealer. Ask your dealer to check the adjustment every six months. Do not use a cam-and-cup front wheel on any bicycle other than the one for which your dealer adjusted it.

3. Removing And Installing Wheels

WARNING

If your bike is equipped with a hub brake such as a rear coaster brake, front or rear drum, band or roller brake; or if it has an internal gear rear hub, do not attempt to remove the wheel.

The removal and re-installation of most hub brakes and internal gear hubs requires special knowledge. Incorrect removal or assembly can result in brake or gear failure, which can cause you to lose control and fall.

CAUTION

If your bike has a disc brake, exercise care in touching the rotor or caliper. Disc rotors have sharp edges, and both rotor and caliper can get very hot during use.

a. Removing a disk brake or rim brake front wheel

- (1) If your bike has rim brakes, disengage the brake's quick-release mechanism to increase the clearance between the tire and the brake pads (See Section 4.C fig. 11 through 15).
- (2) If your bike has cam action front wheel retention, move the cam lever from the locked or CLOSED position to the OPEN position (figs. 8a & b). If your bike has through bolt or bolt-on front wheel retention, loosen the fastener(s) a few turns counter-clockwise using an appropriate wrench, lock key or the integral lever.
- (3) If your front fork has a clip-on type secondary retention device, disengage it . If your front fork has an integral secondary retention device, and a traditional cam action system (fig. 8a) loosen the tension adjusting nut enough to allow removing the wheel from the dropouts. If your front wheel uses a cam-and-cup system, (fig. 8b) squeeze the cup and cam lever together while removing the wheel. No rotation of any part is necessary with the cam-and-cup system.

You may need to tap the top of the wheel with the palm of your hand to release the wheel from the front fork.

b. Installing a disk brake or rim brake front wheel **CAUTION**

If your bike is equipped with a front disk brake, be careful not to damage the disk, caliper or brake pads when re-inserting the disk into the caliper. Never activate a disk brake's control lever unless the disk is correctly inserted in the caliper. See also Section 4.C.

- (1) If your bike has cam action front wheel retention, move the cam lever so that it curves away from the wheel (fig. 8b). This is the OPEN position. If your bike has through bolt or bolt-on front wheel retention, go to the next step.

- (2) With the steering fork facing forward, insert the wheel between the fork blades so that the axle seats firmly at the top of the fork dropouts. The cam lever, if there is one, should be on rider's left side of the bicycle (fig. 8a & b). If your bike has a clip-on type secondary retention device, engage it.
- (3) If you have a traditional cam action mechanism: holding the cam lever in the ADJUST position with your right hand, tighten the tension adjusting nut with your left hand until it is finger tight against the fork dropout (fig. 8a). If you have a cam-and-cup system: the nut and cup (fig. 8b) will have snapped into the recessed area of the fork dropouts and no adjustment should be required.
- (4) While pushing the wheel firmly to the top of the slots in the fork dropouts, and at the same time centering the wheel rim in the fork:
 - (a) With a cam action system, move the cam lever upwards and swing it into the CLOSED position (fig. 8a & b). The lever should now be parallel to the fork blade and curved toward the wheel.

To apply enough clamping force, you should have to wrap your fingers around the fork blade for leverage, and the lever should leave a clear imprint in the palm of your hand.

- (b) With a through-bolt or bolt-on system, tighten the fasteners to the torque specifications in Appendix D or the hub manufacturer's instructions.

NOTE:

If, on a traditional cam action system, the lever cannot be pushed all the way to a position parallel to the fork blade, return the lever to the OPEN position. Then turn the tension adjusting nut counterclockwise one-quarter turn and try tightening the lever again.

- (5) With a through-bolt or bolt-on system, tighten the fasteners to the torque specifications in "PART II Tightening Torques" or the hub manufacturer's instructions.

WARNING

Securely clamping the wheel with a cam action retention device takes considerable force.

If you can fully close the cam lever without wrapping your fingers around the fork blade for leverage, the lever does not leave a clear imprint in the palm of your hand, and the serrations on the wheel fastener do not emboss the surfaces of the dropouts, the tension is insufficient. Open the lever; turn the tension adjusting nut clockwise a quarter turn; then try again.

See also WARNING on page 33.

- (6) If you disengaged the brake quick-release mechanism in 3. a. (1) above, re-engage it to restore correct brake pad-to-rim clearance.
- (7) Spin the wheel to make sure that it is centered in the frame and clears the brake pads; then squeeze the brake lever and make sure that the brakes are operating correctly.

c. Removing a disk brake or rim brake rear wheel

- (1) If you have a multi-speed bike with a derailleur gear system: shift the rear derailleur to high gear (the smallest, outermost rear sprocket).

If you have an internal gear rear hub, consult your dealer or the hub manufacturer's instructions before attempting to remove the rear wheel.

If you have a single-speed bike with rim or disk brake, go to step (4) below.

- (2) If your bike has rim brakes, disengage the brake's quick-release mechanism to increase the clearance between the wheel rim and the brake pads (see Section 4.C, figs. 11 through 15).
- (3) On a derailleur gear system, pull the derailleur body back with your right hand.
- (4) With a cam action mechanism, move the quick-release lever to the OPEN position (fig. 8b). With a through bolt or bolt on mechanism, loosen the fastener(s) with an appropriate wrench, lock lever or integral lever; then push the wheel forward far enough to be able to remove the chain from the rear sprocket.

- (5) Lift the rear wheel off the ground a few inches and remove it from the rear dropouts.

d. Installing a disk brake or rim brake rear wheel

CAUTION

If your bike is equipped with a rear disk brake, be careful not to damage the disk, caliper or brake pads when re-inserting the disk into the caliper. Never activate a disk brake's control lever unless the disk is correctly inserted in the caliper.

- (1) With a cam action system, move the cam lever to the OPEN position (see fig. 8 a & b). The lever should be on the side of the wheel opposite the derailleur and freewheel sprockets.
- (2) On a derailleur bike, make sure that the rear derailleur is still in its outermost, high gear, position; then pull the derailleur body back with your right hand. Put the chain on top of the smallest freewheel sprocket.
- (3) On single-speed, remove the chain from the front sprocket, so that you have plenty of slack in the chain. Put the chain on the rear wheel sprocket.
- (4) Then, insert the wheel into the frame dropouts and pull it all the way in to the dropouts.
- (5) On a single speed or an internal gear hub, replace the chain on the chainring; pull the wheel back in the dropouts so that it is straight in the frame and the chain has about 1/4 inches of up-and-down play.
- (6) With a cam action system, move the cam lever upwards and swing it into the CLOSED position (fig. 8 a & b). The lever should now be parallel to the seat stay or chain stay and curved toward the wheel. To apply enough clamping force, you should have to wrap your fingers around the seat stay or chainstay for leverage, and the lever should leave a clear imprint in the palm of your hand.
- (7) With a through-bolt or bolt-on system, tighten the fasteners to the torque specifications in PART II "Tightening Torques" or the hub manufacturer's instructions.

NOTE: If, on a traditional cam action system, the lever cannot be pushed all the way to a position parallel to the seat stay or chain stay, return the lever to the OPEN position. Then turn the tension adjusting nut counterclockwise one-quarter turn and try tightening the lever again.

 **WARNING**

Securely clamping the wheel with a cam action retention device takes considerable force.

If you can fully close the cam lever without wrapping your fingers around the fork blade for leverage, the lever does not leave a clear imprint in the palm of your hand, and the serrations on the wheel fastener do not emboss the surfaces of the dropouts, the tension is insufficient. Open the lever; turn the tension adjusting nut clockwise a quarter turn; then try again.

See also WARNING on page 33.

- (8) If you disengaged the brake quick-release mechanism in 3. c. (2) above, re-engage it to restore correct brake pad-to-rim clearance.
- (9) Spin the wheel to make sure that it is centered in the frame and clears the brake pads; then squeeze the brake lever and make sure that the brakes are operating correctly.

4.B. Seat Post Cam Action Clamp

Some bikes are equipped with a cam action seat post binder. The seat post cam action binder works exactly like the traditional wheel cam action fastener (Section 4.A.2) While a cam action binder looks like a long bolt with a lever on one end and a nut on the other, the binder uses an over-center cam action to firmly clamp the seat post (see fig. 8a).

 **WARNING**

Riding with an improperly tightened seat post can allow the saddle to turn or move and cause you to lose control and fall. Therefore:

1. Ask your dealer to help you make sure you know how to correctly clamp your seat post.
2. Understand and apply the correct technique for clamping your seat post.
3. Before you ride the bike, first check that the seat post is securely clamped.

Adjusting The Seat Post Cam Action Mechanism

The action of the cam squeezes the seat collar around the seat post to hold the seat post securely in place. The amount of clamping force is controlled by the tension adjusting nut. Turning the tension adjusting nut clockwise while keeping the cam lever from rotating increases clamping force; turning it counterclockwise while keeping the cam lever from rotating reduces clamping force. Less than half a turn of the tension adjusting nut can make the difference between safe and unsafe clamping force.

WARNING

The full force of the cam action is needed to clamp the seat post securely.

Holding the nut with one hand and turning the lever like a wing nut with the other hand until everything is as tight as you can get it will not clamp the seat post safely.

WARNING

If you can fully close the cam lever without wrapping your fingers around the seat post or a frame tube for leverage, and the lever does not leave a clear imprint in the palm of your hand, the tension is insufficient. Open the lever; turn the tension adjusting nut clockwise a quarter turn; then try again.

4.C - Brakes

There are three general types of bicycle brakes: rim brakes, which operate by squeezing the wheel rim between two brake pads; disc brakes, which operate by squeezing a hub-mounted disc between two brake pads; and internal hub brakes. All three can be operated by way of a handlebar mounted lever. On some models of bicycle, the internal hub brake is operated by pedaling backwards. This is called a Coaster Brake and is described in "Coaster Brakes" in this section.

 **WARNINGS**

1. Riding with improperly adjusted brakes or worn brake pads, or wheel on which the rim wear mark is visible is dangerous and can result in serious injury or death.
2. Applying brakes too hard or too suddenly can lock up a wheel, which could cause you to lose control and fall. Sudden or excessive application of the front brake may pitch the rider over the handlebars, which may result in serious injury or death.
3. Some bicycle brakes, such as disc brakes (fig. 11) and linear-pull brakes (fig.12), Are extremely powerful. Take extra care in becoming familiar with these brakes and exercise particular care when using them.
4. Some bicycle brakes are equipped with a brake force modulator, a small, cylindrical device through which the brake control cable runs and which is designed to provide a more progressive application of braking force. A modulator makes the initial brake lever force more gentle, progressively increasing force until full force is achieved. If your bike is equipped with a brake force modulator, take extra care in becoming familiar with its performance characteristics.
5. Disc brakes can get extremely hot with extended use. Be careful not to touch a disc brake until it has had plenty of time to cool.
6. See the brake manufacturer's instructions for installation, operation and care of your brakes. If you do not have the manufacturer's instructions, see your dealer or contact the brake manufacturer.
7. If replacing worn or damaged parts, use only manufacturer approved genuine replacement parts

1. Brake Controls And Features

It's very important to your safety that you learn and remember which brake lever controls which brake on your bike.

Traditionally, in the U.S. the right brake lever controls the rear brake and the left brake lever controls the front brake; but, to check how your bike's brakes are set up, squeeze one brake lever and look to see which brake, front or rear, engages. Now do the same with the other brake lever.

Make sure that your hands can reach and squeeze the brake levers comfortably. If your hands are too small to operate the levers comfortably, consult your dealer before riding the bike. The lever reach may be adjustable; or you may need a different brake lever design.

Most rim brakes have some form of quick-release mechanism to allow the brake pads to clear the tire when a wheel is removed or reinstalled. When the brake quick release is in the open position, the brakes are inoperative. Ask your dealer to make sure that you understand the way the brake quick release works on your bike (see figs. 12, 13, 14 & 15) and check each time to make sure both brakes work correctly before you get on the bike.

2. How Brakes Work

The braking action of a bicycle is a function of the friction between the brake surfaces — usually the brake pads and the wheel rim. To make sure that you have maximum friction available, keep your wheel rims and brake pads clean and free of dirt, lubricants, waxes or polishes.

Brakes are designed to control your speed, not just to stop the bike. Maximum braking force for each wheel occurs at the point just before the wheel "locks up" (stops rotating) and starts to skid. Once the tire skids, you actually lose most of your stopping force and all directional control. You need to practice slowing and stopping smoothly without locking up a wheel. The technique is called progressive brake modulation. Instead of jerking the brake lever to the position where you think you'll generate appropriate braking force, squeeze the lever, progressively increasing the braking force. If you feel the wheel begin to lock up, release pressure just a little to keep the wheel rotating just short of lockup.

It's important to develop a feel for the amount of brake lever pressure required for each wheel at different speeds and on different surfaces. To better understand this, experiment a little by walking your bike and applying different amounts of pressure to each brake lever, until the wheel locks.

When you apply one or both brakes, the bike begins to slow, but your body wants to continue at the speed at which it was going. This causes a transfer of weight to the front wheel (or, under heavy braking, around the front wheel hub, which could send you flying over the handlebars).

A wheel with more weight on it will accept greater brake pressure before lockup; a wheel with less weight will lock up with less brake pressure. So, as you apply brakes and your weight is transferred forward, you need to shift your body toward the rear of the bike, to transfer weight back on to the rear wheel; and at the same time, you need to both decrease rear braking and increase front braking force. This is even more important on descents, because descents shift weight forward.

Two keys to effective speed control and safe stopping are controlling wheel lockup and weight transfer. This weight transfer is even more pronounced if your bike has a front suspension fork. Front suspension "dips" under braking, increasing the weight transfer (see also SECTION 4.F). Practice braking and weight transfer techniques where there is no traffic or other hazards and distractions.

Everything changes when you ride on loose surfaces or in wet weather. Tire adhesion is reduced, so the wheels have less cornering and braking traction and can lock up with less brake force. Moisture or dirt on the brake pads reduces their ability to grip. The way to maintain control on loose or wet surfaces is to go more slowly.

More info:

ROAD BIKES: DISC BRAKES

Now, go to PART II of this manual and read "Understanding Disc Brakes on Road Bikes"

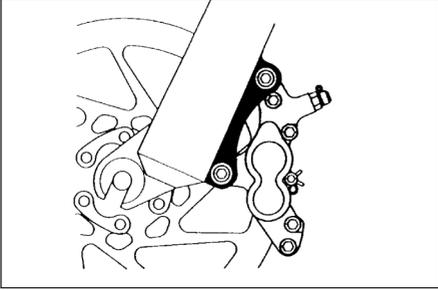

Figure 11.

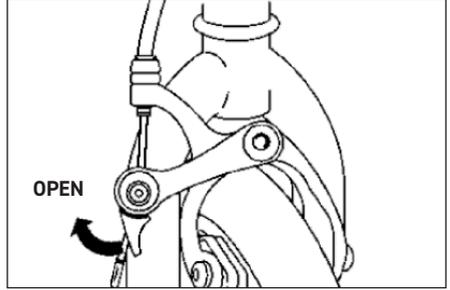

Figure 14.

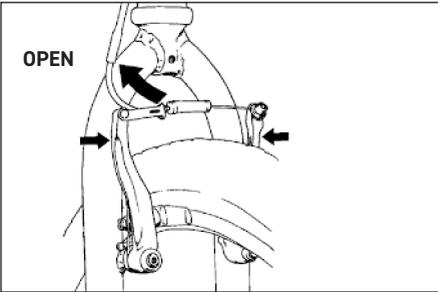

Figure 12.

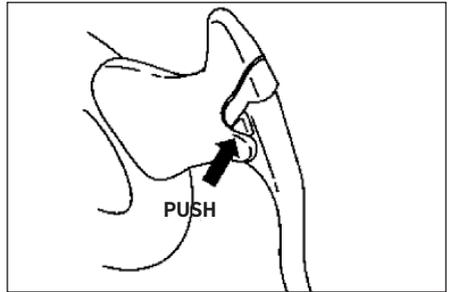

Figure 15.

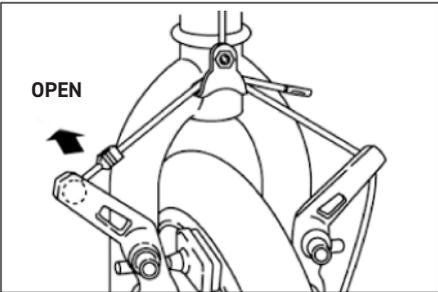
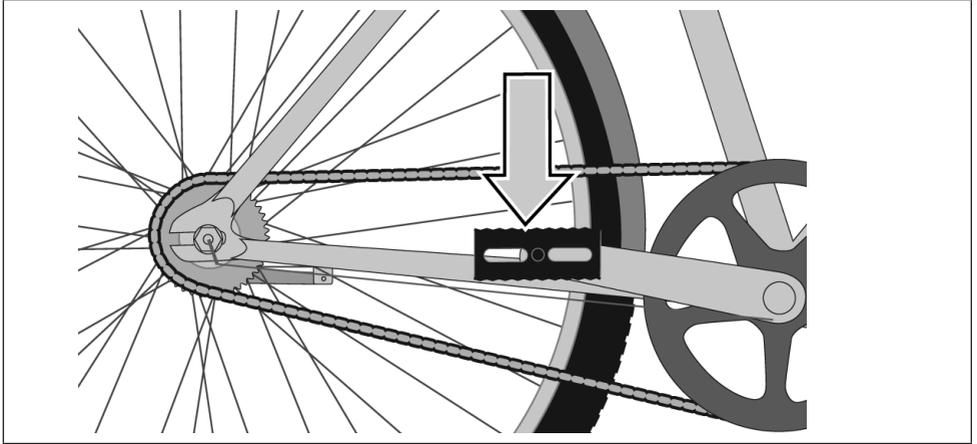

Figure 13.

Coaster Brakes



1. How the coaster brake works

The coaster brake is a sealed mechanism which is a part of the bicycle's rear wheel hub. The brake is activated by reversing the rotation of the pedal cranks (indicated by arrow above). Start with the pedal cranks in a nearly horizontal position, with the front pedal in about the 4 o'clock position, and apply downward foot pressure on the pedal that is to the rear. About 1/8 turn rotation will activate the brake. The more downward pressure you apply, the more braking force, up to the point where the rear wheel stops rotating and begins to skid.

WARNING

Before riding, make sure that the brake is working properly. If it is not working properly, have the bicycle checked by your dealer before you ride it.

WARNING

If your bike has only a coaster brake, ride conservatively. A single rear brake does not have the stopping power of front-and-rear brake systems.

2. Adjusting your coaster brake

Coaster brake service and adjustment requires special tools and special knowledge. Do not attempt to disassemble or service your coaster brake. Take the bicycle to your dealer for coaster brake service.

4.D - Shifting Gears

Your multi-speed bicycle will have a derailleur drivetrain (see 1. below), an internal gear hub drivetrain (see 2. below) or, in some special cases, a combination of the two.

1. How a derailleur drivetrain works

If your bicycle has a derailleur drivetrain, the gear-changing mechanism will have:

- a rear cassette or freewheel sprocket cluster
- a rear derailleur
- usually a front derailleur
- one or two shifters
- one, two or three front sprockets called chainrings
- a drive chain

a. Shifting Gears

There are several different types and styles of shifting controls: levers, twist grips, triggers, combination shift/brake controls, push-buttons, and so on. Ask your dealer to explain the type of shifting controls that are on your bike, and to show you how they work.

The vocabulary of shifting can be pretty confusing. A downshift is a shift to a "lower" or "slower" gear, one which is easier to pedal. An upshift is a shift to a "higher" or "faster", harder to pedal gear. What's confusing is that what's happening at the front derailleur is the opposite of what's happening at the rear derailleur (for details, read the instructions on Shifting the Rear Derailleur and Shifting the Front Derailleur below).

For example, you can select a gear which will make pedaling easier on a hill (make a downshift) in one of two ways: shift the chain down the gear "steps" to a smaller gear at the front, or up the gear "steps" to a larger gear at the rear. So, at the rear gear cluster, what is called a downshift looks like an upshift.

The way to keep things straight is to remember that shifting the chain in towards the centerline of the bike is for accelerating and climbing and is called a downshift. Moving the chain out or away from the centerline of the bike is for speed and is called an upshift.

Whether upshifting or downshifting, the bicycle derailleur system design requires that the drive chain be moving forward and be under at least some tension. A derailleur will shift only if you are pedaling forward.

 **CAUTION**

Never move the shifter while pedaling backward, nor pedal backwards immediately after having moved the shifter. This could jam the chain and cause serious damage to the bicycle.

b. Shifting the Rear Derailleur

The rear derailleur is controlled by the right shifter.

The function of the rear derailleur is to move the drive chain from one gear sprocket to another. The smaller sprockets on the gear cluster produce higher gear ratios.

Pedaling in the higher gears requires greater pedaling effort, but takes you a greater distance with each revolution of the pedal cranks. The larger sprockets produce lower gear ratios. Using them requires less pedaling effort, but takes you a shorter distance with each pedal crank revolution. Moving the chain from a smaller sprocket of the gear cluster to a larger sprocket results in a downshift. Moving the chain from a larger sprocket to a smaller sprocket results in an upshift. In order for the derailleur to move the chain from one sprocket to another, the rider must be pedaling forward.

c. Shifting the Front Derailleur:

The front derailleur, which is controlled by the left shifter, shifts the chain between the larger and smaller chainrings. Shifting the chain onto a smaller chainring makes pedaling easier (a downshift). Shifting to a larger chainring makes pedaling harder (an upshift).

d. Which gear should I be in?

The combination of largest rear and smallest front gears (fig. 16) is for the steepest hills. The smallest rear and largest front combination is for the greatest speed. It is not necessary to shift gears in sequence. Instead, find the "starting gear" which is right for your level of ability — a gear which is hard enough for quick acceleration but easy enough to let you start from a stop without wobbling — and experiment with upshifting and downshifting to get a feel for the different gear combinations. At first, practice shifting where there are no obstacles, hazards or other traffic, until you've built up your confidence. Learn not to use either the "smallest-to-smallest" or "largest-to-largest" gear combinations because they can cause unacceptable stress on the drive change. Learn to anticipate the need to shift, and shift to a lower gear before the hill gets too steep. If you have difficulties with shifting, the problem could be mechanical adjustment. See your dealer for help.

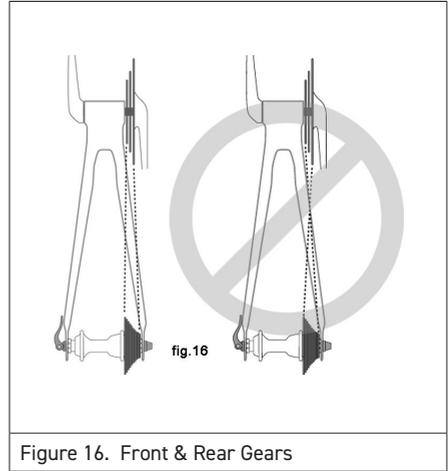

Figure 16. Front & Rear Gears

WARNING

Never shift a derailleur onto the largest or the smallest sprocket if the derailleur is not shifting smoothly.

The derailleur may be out of adjustment and the chain could jam, causing you to lose control and fall.

e. What if it won't shift gears?

If moving the shift control one click repeatedly fails to result in a smooth shift to the next gear chances are that the mechanism is out of adjustment. Take the bike to your dealer to have it adjusted.

2. How an internal gear hub drivetrain works

If your bicycle has an internal gear hub drivetrain, the gear changing mechanism will consist of:

- a 3, 5, 7, 8, 12 speed or possibly an infinitely variable internal gear hub
- one, or sometimes two shifters
- one or two control cables
- one front sprocket called a chainring
- a drive chain

a. Shifting internal gear hub gears

Shifting with an internal gear hub drivetrain is simply a matter of moving the shifter to the indicated position for the desired gear. After you have moved the shifter to the gear position of your choice, ease the pressure on the pedals for an instant to allow the hub to complete the shift.

b. Which gear should I be in?

The numerically lowest gear (1) is for the steepest hills. The numerically largest gear is for the greatest speed.

Shifting from an easier, "slower" gear (like 1) to a harder, "faster" gear (like 2 or 3) is called an upshift. Shifting from a harder, "faster" gear to an easier, "slower" gear is called a downshift. It is not necessary to shift gears in sequence. Instead, find the "starting gear" for the conditions — a gear which is hard enough for quick acceleration but easy enough to let you start from a stop without wobbling — and experiment with upshifting and downshifting to get a feel for the different gears. At first, practice shifting where there are no obstacles, hazards or other traffic, until you've built up your confidence. Learn to anticipate the need to shift, and shift to a lower gear before the hill gets too steep. If you have difficulties with shifting, the problem could be mechanical adjustment. See your dealer for help.

c. What if it won't shift gears?

If moving the shift control one click repeatedly fails to result in a smooth shift to the next gear chances are that the mechanism is out of adjustment. Take the bike to your dealer to have it adjusted.

4.E - Pedals

1. Toe Overlap is when your toe can touch the front wheel when you turn the handlebars to steer while a pedal is in the forwardmost position. This is common on small-framed bicycles, and is avoided by keeping the inside pedal up and the outside pedal down when making sharp turns. This technique will also prevent the inside pedal from striking the ground in a turn.

NOTE: Changing tire size or pedal arm length affect toe clip overlap.

WARNING

Toe overlap could cause you to lose control and fall.

Ask your dealer to help you determine if the combination of frame size, crank arm length, pedal design and shoes you will use results in pedal overlap.

Whether you have overlap or not, you must keep the inside pedal up and the outside pedal down when making sharp turns.

2. Some bicycles come equipped with pedals that have sharp and potentially dangerous surfaces. These surfaces are designed to add safety by increasing grip between the rider's shoe and the pedal.

If your bicycle has this type of high-performance pedal, you must take extra care to avoid serious injury from the pedals' sharp surfaces.

Based on your riding style or skill level, you may prefer a less aggressive pedal design, or chose to ride with shin pads. Your dealer can show you a number of options and make suitable recommendations.

3. Toeclips and straps are a means to keep feet correctly positioned and engaged with the pedals.

The toeclip positions the ball of the foot over the pedal spindle, which gives maximum pedaling power. The toe strap, when tightened, keeps the foot engaged throughout the rotation cycle of the pedal.

While toeclips and straps give some benefit with any kind of shoe, they work most effectively with cycling shoes designed for use with toeclips.

Your dealer can explain how toeclips and straps work. Shoes with deep treaded soles or welts which might allow the foot to be trapped should not be used with toeclips and straps.

 **WARNING**

Getting into and out of pedals with toeclips and straps requires skill which can only be acquired with practice.

Until it becomes a reflex action, the technique requires concentration which can distract your attention and cause you to lose control and fall.

Practice the use of toeclips and straps where there are no obstacles, hazards or traffic. Keep the straps loose, and don't tighten them until your technique and confidence in getting in and out of the pedals warrants it. Never ride in traffic with your toe straps tight.

4. Clipless pedals (sometimes called "step-in pedals") are another means to keep feet securely in the correct position for maximum pedaling efficiency. They have a plate, called a "cleat," on the sole of the shoe, which clicks into a mating spring-loaded fixture on the pedal.

They only engage or disengage with a very specific motion which must be practiced until it becomes instinctive. Clipless pedals require shoes and cleats which are compatible with the make and model pedal being used.

Many clipless pedals are designed to allow the rider to adjust the amount of force needed to engage or disengage the foot. Follow the pedal manufacturer's instructions, or ask your dealer to show you how to make this adjustment. Use the easiest setting until engaging and disengaging becomes a reflex action, but always make sure that there is sufficient tension to prevent unintended release of your foot from the pedal.

 **WARNING**

Clipless pedals are intended for use with shoes specifically made to fit them and are designed to firmly keep the foot engaged with the pedal.

Do not use shoes which do not engage the pedals correctly.

Practice is required to learn to engage and disengage the foot safely. Until engaging and disengaging the foot becomes a reflex action, the technique requires concentration which can distract your attention and cause you to lose control and fall. Practice engaging and disengaging clipless pedals in a place where there are no obstacles, hazards or traffic; and be sure to follow the pedal manufacturer's setup and service instructions. If you do not have the manufacturer's instructions, see your dealer or contact the manufacturer.

4.F - Bicycle Suspension

Many bicycles are equipped with suspension systems. There are many different types of suspension systems — too many to deal with individually in this Manual. If your bicycle has a suspension system of any kind, be sure to read and follow the suspension manufacturer's setup and service instructions. If you do not have the manufacturer's instructions, see your dealer or contact the manufacturer.

WARNING

Failure to maintain, check and properly adjust the suspension system may result in suspension malfunction, which may cause you to lose control and fall.

If your bike has suspension, the increased speed you may develop also increases your risk of injury. For example, when braking, the front of a suspended bike dips. You could lose control and fall if you do not have experience with this system. Learn to handle your suspension system safely. See also SECTION 4.C.

WARNING

Changing suspension adjustment can change the handling and braking characteristics of your bicycle.

Never change suspension adjustment unless you are thoroughly familiar with the suspension system manufacturer's instructions and recommendations, and always check for changes in the handling and braking characteristics of the bicycle after a suspension adjustment by taking a careful test ride in a hazard-free area.

Suspension can increase control and comfort by allowing the wheels to better follow the terrain. This enhanced capability may allow you to ride faster; but you must not confuse the enhanced capabilities of the bicycle with your own capabilities as a rider. Increasing your skill will take time and practice. Proceed carefully until you have learned to handle the full capabilities of your bike.

 **WARNING**

Not all bicycles can be safely retrofitted with some types of suspension systems. Before retrofitting a bicycle with any suspension, check with the bicycle's manufacturer to make sure that what you want to do is compatible with the bicycle's design. Failing to do so can result in catastrophic frame failure.

4.G Tires and Tubes

 **WARNING**

Some bicycles intended for competition are fitted with tires that are glued on to specially made rims. These are called "sew-up" or "tubular" tires. Properly mounting these tires requires specialized knowledge and skills. Ask your dealer to teach you how to mount tubulars before you attempt it on your own. An incorrectly installed tubular tire can come off the rim, causing you to lose control and fall.

1. Tires

Bicycle tires are available in many designs and specifications, ranging from general-purpose designs to tires designed to perform best under very specific weather or terrain conditions. If, once you've gained experience with your new bike, you feel that a different tire might better suit your riding needs, your dealer can help you select the most appropriate design.

The size, pressure rating, and on some high-performance tires the specific recommended use, are marked on the sidewall of the tire (see fig. 17).

The part of this information which is most important to you is Tire Pressure. But some wheel rim manufacturers also specify maximum tire pressure with a label on the rim.

 **WARNING**

Never inflate a tire beyond the maximum pressure marked on the tire's sidewall or the wheel rim.

If the maximum pressure rating for the wheel rim is lower than the maximum pressure shown on the tire, always use the lower rating. Exceeding the recommended maximum pressure may blow the tire off the rim or damage the wheel rim, which could cause damage to the bike and injury to the rider and bystanders.

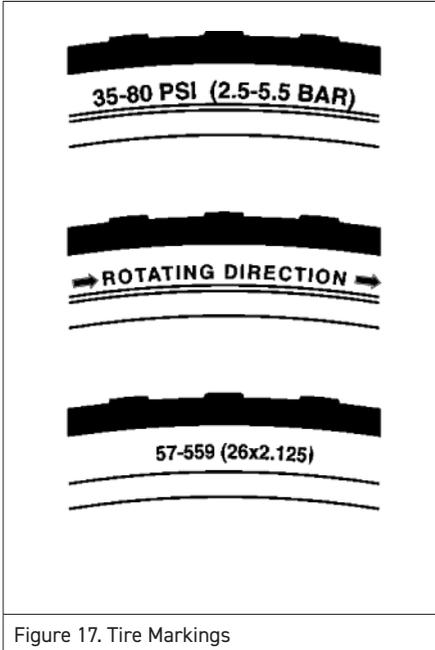

Figure 17. Tire Markings

Tire pressure is given either as maximum pressure or as a pressure range. How a tire performs under different terrain or weather conditions depends largely on tire pressure. Inflating the tire to near its maximum recommended pressure gives the lowest rolling resistance; but also produces the harshest ride. High pressures work best on smooth, dry pavement.

Very low pressures, at the bottom of the recommended pressure range, give the best performance on smooth, slick terrain such as hard-packed clay, and on deep, loose surfaces such as deep, dry sand.

Tire pressure that is too low for your weight and the riding conditions can cause a puncture of the tube by allowing the tire to deform sufficiently to pinch the inner tube between the rim and the riding surface. This may also result in damage.

The best and safest way to inflate a bicycle tire to the correct pressure is with a bicycle pump which has a built-in pressure gauge.

WARNING

There is a safety risk in using gas station air hoses or other air compressors.

They are not made for bicycle tires. They move a large volume of air very rapidly, and will raise the pressure in your tire very rapidly, which could cause the tube to explode.

 **CAUTION**

Pencil type automotive tire gauges can be inaccurate and should not be relied upon for consistent, accurate pressure readings. Instead, use a high quality dial gauge.

Ask your dealer to recommend the best tire pressure for the kind of riding you will most often do, and have the dealer inflate your tires to that pressure. Then, check inflation as described in SECTION 1.C so you'll know how correctly inflated tires should look and feel when you don't have access to a gauge.

Some tires may need to be brought up to pressure every week or two. So, it is important to check your tire pressures before every ride.

Some special high-performance tires have unidirectional treads: their tread pattern is designed to work better in one direction than in the other. The sidewall marking of a unidirectional tire will have an arrow showing the correct rotation direction. If your bike has unidirectional tires, be sure that they are mounted to rotate in the correct direction.

2. Tire Valves

There are primarily two kinds of bicycle tube valves: The Schrader Valve and the Presta Valve. The bicycle pump you use must have the fitting appropriate to the valve stems on your bicycle.

The Schrader valve (fig. 18) is like the valve on a car tire. To inflate a Schrader valve tire, remove the valve cap and clamp the pump fitting onto the end of the valve stem. To let air out of a Schrader valve, depress the pin in the end of the valve stem with the end of a key or other appropriate object.

The Presta valve (fig. 18) has a narrower diameter and is only found on bicycle tires. To inflate a Presta valve tire using a Presta headed bicycle pump, remove the valve cap; unscrew (counterclockwise) the valve stem lock nut; and push down on the valve stem to free it up. Then push the pump head on to the valve head, and inflate. To inflate a Presta valve with a Schrader pump fitting, you'll need a Presta adapter (available at your bike shop) which screws on to the valve stem once you've freed up the valve. The adapter fits into the Schrader pump fitting. Close the valve after inflation. To let air out of a Presta valve, open up the valve stem lock nut and depress the valve stem.

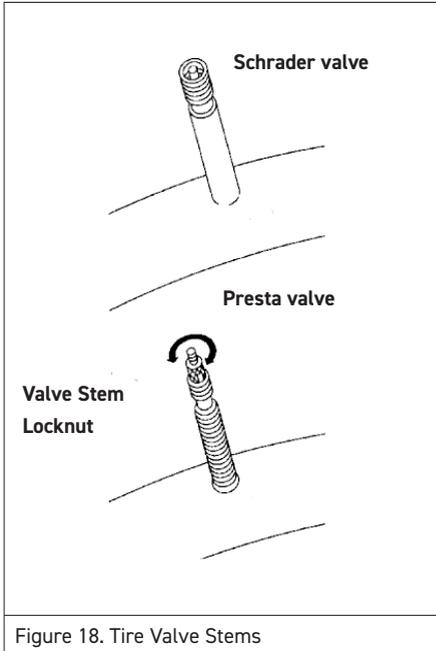

Figure 18. Tire Valve Stems

WARNING

We highly recommend that you carry a spare inner tube when you ride your bike.

Patching a tube is an emergency repair.

If you do not apply the patch correctly or apply several patches, the tube can fail, resulting in possible tube failure, which could cause you to lose control and fall. Replace a patched tube as soon as possible.

Section 5. Service

WARNING

Technological advances have made bicycles and bicycle components more complex, and the pace of innovation is increasing.

It is impossible for this manual to provide all the information required to properly repair and/or maintain your bicycle.

In order to help minimize the chances of an accident and possible injury, it is critical that you have any repair or maintenance which is not specifically described in this manual performed by your dealer. Equally important is that your individual maintenance requirements will be determined by everything from your riding style to geographic location.

Consult your dealer for help in determining your maintenance requirements.

 **WARNING****Many bicycle service and repair tasks require special knowledge and tools.**

Do not begin any adjustments or service on your bicycle until you have learned from your dealer how to properly complete them.

Improper adjustment or service may result in damage to the bicycle or in an accident which can cause serious injury or death.

If you want to learn to do major service and repair work on your bike, you have three options:

1. Ask your dealer for copies of the manufacturer's installation and service instructions for the components on your bike, or contact the component manufacturer.
2. Ask your dealer to recommend a book on bicycle repair.
3. Ask your dealer about the availability of bicycle repair courses in your area.

We recommend that you ask your dealer to check the quality of your work the first time you work on something and before you ride the bike, just to make sure that you did everything correctly. Since that will require the time of a mechanic, there may be a modest charge for this service.

We also recommend that you ask your dealer for guidance on what spare parts, such as inner tubes, light bulbs, etc. it would be appropriate for you to have once you have learned how to replace such parts when they require replacement.

5.A - Service Intervals

Some service and maintenance can and should be performed by the owner, and require no special tools or knowledge beyond what is presented in this manual.

The following are examples of the type of service you should perform yourself. All other service, maintenance and repair should be performed in a properly equipped facility by a qualified bicycle mechanic using the correct tools and procedures specified by the manufacturer.

1. **BREAK-IN PERIOD:** Your bike will last longer and work better if you break it in before riding it hard. Control cables and wheel spokes may stretch or "seat" when a new bike is first used and may require readjustment by your dealer. Your Mechanical Safety Check (SECTION 1.C) will help you identify some things that need readjustment. But even if everything seems fine to you, it's best to take your bike back to the dealer for a checkup.

Dealers typically suggest you bring the bike in for a 30 day checkup.

Another way to judge when it's time for the first checkup is to bring the bike in after three to five hours of hard off-road use, or about 10 to 15 hours of on-road or more casual off-road use. But if you think something is wrong with the bike, take it to your dealer before riding it again.

2. **BEFORE EVERY RIDE:** Mechanical Safety Check (SECTION 1.C)
3. **AFTER EVERY LONG OR HARD RIDE:** If the bike has been exposed to water or grit; or at least every 100 miles: Clean the bike and lightly lubricate the chain's rollers with a good quality bicycle chain lubricant. Wipe off excess lubricant with a lint-free cloth. Lubrication is a function of climate. Talk to your dealer about the best lubricants and the recommended lubrication frequency for your area.
4. **AFTER EVERY LONG OR HARD RIDE OR AFTER EVERY 10 TO 20 HOURS OF RIDING:**
 - Squeeze the front brake and rock the bike forward and back. Everything feel solid? If you feel a clunk with each forward or backward movement of the bike, you probably have a loose headset. Have your dealer check it.

- Lift the front wheel off the ground and swing it from side to side. Feel smooth? If you feel any binding or roughness in the steering, you may have a tight headset. Have your dealer check it.
 - Grab one pedal and rock it toward and away from the centerline of the bike; then do the same with the other pedal. Anything feel loose? If so, have your dealer check it.
 - Take a look at the brake pads. Are they worn or not hitting the wheel rim squarely? Time to have the dealer adjust or replace them.
 - Carefully check the control cables and cable housings. Any rust? Kinks? Fraying? If so, have your dealer replace them.
 - Squeeze each adjoining pair of spokes on either side of each wheel between your thumb and index finger. Do they all feel about the same? If any feel loose, have your dealer check the wheel for tension and trueness.
 - Check the tires for excess wear, cuts or bruises. Have your dealer replace them if necessary.
 - Check the wheel rims for excess wear, dings, dents and scratches. Consult your dealer if you see any rim damage.
 - Check to make sure that all parts and accessories are still secure, and tighten any that are not.
 - Check the frame, particularly in the area around all tube joints; the handlebars; the stem; and the seatpost for any deep scratches, cracks or discoloration. These are signs of stress-caused fatigue and indicate that a part is at the end of its useful life and needs to be replaced. See also Appendix C.

See also PART II, SECTION D. INSPECT FOR SAFETY.
5. Disc brakes require a different set of inspection steps. Check for these issues before every ride::
- Pads rubbing on rotors.
 - Worn out pads (which can lead to over-extended pistons).
 - Pistons that are stuck and/or won't retract fully.
 - Disc rotors that are bent and need straightening by the dealer.

- Hydraulic brakes that feel “sponge-y” and/or levers that can be depressed all the way to the grips w/o generating adequate stopping power (due to trapped air and/or leaks).
6. As required: If either brake lever fails the Mechanical Safety Check (Section 1.C), don't ride the bike. Have your dealer check the brakes. If the chain won't shift smoothly and quietly from gear to gear, the derailleur is out of adjustment. See your dealer..
 7. Every 25 (hard off-road) to 50 (on-road) hours of riding: Take your bike to your dealer for a complete checkup.

 **WARNING**

Like any mechanical device, a bicycle and its components are subject to wear and stress. Different materials and mechanisms wear or fatigue from stress at different rates and have different life cycles. If a component's life cycle is exceeded, the component can suddenly and catastrophically fail, causing serious injury or death to the rider

 **WARNING**

Scratches, cracks, fraying and discoloration are signs of stress-caused fatigue and indicate that a part is at the end of its useful life and needs to be replaced.

While the materials and workmanship of your bicycle or of individual components may be covered by a warranty for a specified period of time by the manufacturer, this is no guarantee that the product will last the term of the warranty. Product life is often related to the kind of riding you do and to the treatment to which you submit the bicycle. The bicycle's warranty is not meant to suggest that the bicycle cannot be broken or will last forever. It only means that the bicycle is covered subject to the terms of the warranty.

Please be sure to also read Part 2 Section B. Intended Use.

Please be sure to also read Part 2 Section D. Inspect for Safety, Bicycle Lifespan.

5.B - If Your Bicycle Sustains An Impact:

First, check yourself for injuries, and take care of them as best you can. Seek medical help if necessary.

Next, check your bike for damage.

After any crash, take your bike to your dealer for a thorough check.

Carbon composite components, including frames, wheels, handlebars, stems, cranksets, brakes, etc. which have sustained an impact must not be ridden until they have been disassembled and thoroughly inspected by a qualified mechanic.

Please be sure to also read Part 2 Section D. Inspect for Safety, Bicycle Lifespan.

 **WARNING**

A crash or other impact can put extraordinary stress on bicycle components, causing them to fatigue prematurely.

Components suffering from stress fatigue can fail suddenly and catastrophically, causing loss of control, serious injury or death.

Appendix A.

Teaching Your Child the Rules

We cannot over-state how important this entire owner's manual is to the rider's safety.

We also understand Kids need to be taught ... and to have frequently reinforced ... the following rules and lessons which adults are already expected to know.

We urge you to take the time to familiarize yourself with this owner's manual and the rules in this section.

Teach the rules to your child before you let your child ride unsupervised.

1. Rules

- No playing in the road or in the street.
- No riding on busy streets.
- No riding at dawn, dusk or at night.
- Stop for all STOP signs.
- Ride on the right of traffic.

2. Lessons

The lessons that follow relate to some of the most common real situations that children encounter when riding their bikes. Go over these situations with your child and make sure the lesson objective is accomplished.

a. Driveway Ride out

When a youngster rides out of the driveway and is struck by a car, that is called a ride out accident.

What can you do? First, realize the danger of your own driveway. If there are obstructions to the view of passing motorists (like bushes or trees), trim them back. You might park your car in front of the driveway, if local ordinance permits.

This way, your child can't use the driveway as a launching pad. But the most important thing you can do is teach your child about driveway safety. Take your child outside to the driveway and have him/her practice the following steps:

- 1) Stop before entering the street.
- 2) Look left, right and left again for traffic.
- 3) If there's no traffic, proceed into the roadway.

b. Running a Stop Sign

Car/bike crashes can happen when a cyclist runs a stop sign. Most cyclists who get hit riding through stop signs know that they were supposed to stop. They just thought it would be OK this time; or they may have been distracted. The thing to impress upon your child is that while he/she may not get hit every time, running stop signs will eventually result in an accident.

What can you do? Take your child to a stop sign near home. Explain what it means by emphasizing the following points:

- 1) Stop at all stop signs, regardless of what is happening.
- 2) Look in all directions for traffic.
- 3) Watch for oncoming cars making left turns.
- 4) Watch for cars behind you making right turns.
- 5) Wait for any cross traffic to clear.
- 6) Proceed when safe.

In order to make this lesson stick, you may have to change your own driving habits. If you creep through intersections controlled by stop signs, you are showing your child that you don't really believe what you preach. For your child's sake, stop at stop signs.

c. Turning Without Warning

Another major accident type involves cyclists who make unexpected left turns. They neither look behind for traffic, nor do they signal. The key factor here is neglecting to look to the rear. If the cyclist had looked, he/she would have seen the danger coming up from behind.

What can you do? Of course, you ought to teach your child not to ride across busy streets - at least until the child has had some advanced training and is old enough to understand traffic. But in the meantime, for residential street riding, you can teach your child to always look and signal before turning left. A big part of this lesson is teaching the child how to look to the rear without swerving.

Take your child to a safe area away from traffic or obstructions to practice riding along a straight line while looking behind. Stand alongside and hold up a different number of fingers on your hand after the child rides by. Call his/her name. After 15 minutes of practice, a ten year old should be able to look behind his/herself and identify how many fingers you are holding up - without swerving.

d. Riding at Dawn, at Dusk or at Night

Most car/bicycle accidents happen at night where an overtaking car hits a bike. (An overtaking car is one that comes up from behind and passes the cyclist on the left.) These overtaking accidents can be very serious.

What can you do? First, you should keep your child from riding at dawn, dusk or at night. It requires special skills and equipment.

Few children have either. Secondly, make sure your child understands that if he/she gets caught out at dusk or after dark on a bike, the thing to do is to call you for a ride home. One suggestion is to have your child carry a cell phone, and as an added precaution, tape a phone number to the bike so that, in an emergency, an adult will be able to call home.

e. Following the Leader

There is increased risk of car/bike collision if children are following each other, because if the first one does something dangerous, those following may do it too.

What can you do? Teach your child to always assess the traffic situation for him/herself. When riding cyclists are riding in a group, each cyclist should stop for stop signs; each cyclist should look to the rear before making left turns; and so on. One way to get the message across is to play a game with the child similar to 'Simon Says'. In this game, however, the emphasis should not be on doing what 'Simon Says', but rather have the child make a decision based on the situation. The child should learn to ignore what 'Simon Says'. Children need to learn to think for themselves to ride safely.

Summary

Teach your child early - the earlier the better. Learning skills such as looking and avoiding hazards takes time. Be prepared to repeat lessons until your child understands what you're trying to get across. Be patient. Your efforts will be rewarded, knowing that your child is aware of safe riding skills.

PART 2

Section A. Important Safety Information

A Wide Range Of Bicycling Injuries Are Possible

Many hazards are described, and we have attempted to explain how to avoid or minimize the dangers. Because any fall can result in serious injury, paralysis or death we do not repeat the warning of these potential consequences every time we call attention to a hazard. Some low speed falls may result in serious injuries, and some wild high speed falls may result in none. The reality is that the exact nature of the consequences of a fall or accident is not predictable.

Bicycles Cannot Protect You

Bicycles are lightweight, human-powered vehicles. Unlike a car, much like a motorcycle, there is no restraint system for your body, no protective structure around your body. Crash worthiness cannot be a design criterion. A rider sits on a bicycle and can be easily thrown off for many reasons including overly hard use of the front brakes (See PART I, SECTION 4.C Brakes) or striking an obstacle.

Bicycling Inherent Risk

WARNING

BICYCLING IS AN ACTIVE SPORT WITH INHERENT RISK.

"Inherent risk," means that due to the nature of bicycle riding, the situations you encounter while riding expose you to the risk of serious injury, paralysis, or death in an accident.

The risk cannot be taken away or eliminated. You can minimize risk by doing the following:

Bicycle training & practice

Progressive step-by-step learning of new cycling skills

The good judgement to ride in control

Bicycle experience, riding with experienced riders

Use of a proper bicycle helmet and appropriate protective gear

Reading and thinking about this entire owner's manual, all owner's manual supplements and instructions that came with your bicycle are essential to your safety and part of the learning process. Visit www.gtbicycles.com.

Riding within your own unique capabilities and considering the conditions where you are riding.

Warning Label

We urge you to locate the warning label on your bike. It contains important information that you and anyone else who rides your bike should read and follow.

Do not remove it. If you bought an older bike or are refinishing one of our bikes, contact us for a no charge replacement.



Figure 19.

Riding In Traffic, Commuting

WARNING

Riding in traffic (and commuting) is hazardous and you can be severely injured or killed doing it.

As noted in PART I of this manual, you must learn and obey local traffic laws. Riding in traffic is hazardous. We cannot teach you about all of these hazards.

We suggest:

Effective Cycling (ISBN 0-262-06159-7) by John Forester.

And, www.bicyclesafe.com by Michael Bluejay "How to Not Get Hit by Cars: Important lessons on Bicycle Safety"

Here are just some important topics you must consider:

Traffic Law, Accidents, Intersections, Commuting And Utility Cycling Where To Ride, On Roadway, Changing Lanes In Traffic, Riding At Night, Improving Your Odds With Safety, Lighting, And Weather Equipment

Many bike clubs conduct training programs and workshops that focus on these and other safe cycling topics. Ask at your local bike shop. Seek the advice of an experienced bicycle commuter at your retailer.

Riding At Night, Dusk, Dawn

WARNING

RIDING AT NIGHT/DUSK OR AT DAWN IS VERY HAZARDOUS.

Avoid riding at night. If you choose to ride at night:

Install front and rear lights.

Wear reflective clothing.

Install a blinker or strobe light.

Stay alert, others may not see you.

Check your state or national laws. Lights are required for riding at dusk, night, or dawn.

Make sure your bicycle is equipped with all required reflectors, lights, strobes, or blinkers.

Required Reflectors

The location and type of each reflector on your bike is required by a national authority, in the US, the US Consumer Product Safety Commission (CPSC). Your GT bike must be delivered with: 1. A front mounted forward facing reflector 2. A rear mounted, rear facing reflector, 3. A spoke mounted reflector on each wheel, 4. Front and rear facing reflectors on the left and right pedal. **DO NOT REMOVE, BLOCK, OR COVER REFLECTORS.**

Much Higher Risks At Night

The risk of an accident, particularly being struck by a motor vehicle, is much higher at night. If you choose to accept this higher risk, improve your odds with a proper lighting system, strobe light, light colored reflective clothing and careful riding. Seek the advice of an experienced bicycle commuter at your retailer.

continued . . .

continued from previous page . . .

Mountain Biking At Night:

Mountain biking at night is risky. Take the challenges outlined in SECTION C. and add another level of difficulty and risk. Seeing the terrain is much more difficult at night. Mountain biking at night is only for skilled mountain bikers, on familiar terrain, with excellent light systems, riding with other skilled mountain bikers, and riding cautiously.

Adding Lighting:

Reflectors are not a substitute for proper lights. It is your responsibility to equip your bicycle with all national, state and locally mandated lights.

Riding at dawn, at dusk, at night or at other times of poor visibility without a bicycle lighting system which meets local and state laws and without reflectors is dangerous and may result in serious injury or death.

If you ride your bike before dawn or after dusk, your bicycle must be equipped with lights so that you can see the road and avoid road hazards, and so that others can see you. Traffic laws treat bicycles like any other vehicle. That means you must have a white front and a red rear light operating if you are riding after dusk. Your bike dealer can recommend a battery or generator powered lighting system appropriate to your needs.

Flashing (blinker) and Strobe Lighting

We also strongly urges you to use a flashing light or strobe. All of us at who ride at night or in conditions of lower visibility use flashers. They can save your life. (Yeah, we know there may be legal issues with flashers in some areas. They can save your life. Enough said.)

Understanding E-bikes

What is an E-bike?

Electric bikes, also known as “E-Bikes” are bicycles equipped with an electric pedal assist drive system. An E-Bike IS NOT a moped or motorcycle. E-bikes share components common with pedal-only bikes.

What is a Drive System?

The drive-assist system consists of a drive unit, a battery, a computer control, and various electronic components (harness wires, sensors, and switches). There are many different drive-assist systems for differing uses and bike types. Likewise there are various drive-assist system manufacturers (Shimano, BOSCH, Bafang, Yamaha, etc.)

How does the Drive System work?

A Drive System can be throttle based, pedal assist based, or both.

Throttle Controlled Drive

For a drive system equipped with a throttle, it is important to know that when the drive-assist system is turned ON, the drive unit engages to provide power when the throttle is pressed.

Pedal Assisted Drive

For a drive system that is pedal assist only, It is important to know that when the drive-assist system is turned ON, the drive unit engages to provide power only while you are pedaling. The amount of power provided by the drive unit depends on your pedaling force and the assistance mode/level you set with the handlebar control unit. With a pedal-assist system, if you stop pedaling, the drive-assist will disengage.

Limit Assistance / Maximum Speed Allowable

The drive-assist system power reduces progressively and cuts off as the bike reaches a the maximum allowable speed. The drive-assist re-engages when speed drops below the maximum allowable speed as long as the pedals are turning. Whenever the drive-assist system is turned OFF, you can pedal the bike normally. The drive system will not engage.

Drive System Parts E-Bike

The example shown below is a E-Bike in the Mountain category. There are many different bkes that have these same basic drive system components.



Identification

1. Drive unit
2. Drive Controls/Display
3. Internal Battery
4. Charge port
5. Wheel Sensor
6. Serial number

Operating an E-Bike (1 of 4)

WARNINGS

Operating the Drive Assist System

Turning the drive assist system ON before you are seated and have both hands on the handlebar could result in loss of control of the E-bike. Always have total control of the E-bike and be ready to ride before engaging the drive system.

The E-bike's drive assist system will increase or decrease the acceleration of the bike. It is the rider's responsibility to appropriately judge the riding conditions (e.g. road conditions, tight turns) and current speed of the E-bike before adjusting the drive assist system.

Anticipating changes in speed and providing time to react appropriately is critical to using the drive assist system. Always check your surroundings and conditions before accelerating and set the assistance level to lowest assist, or off, when descending hills.

The drive assist system will not function properly without the display (E-bike computer) properly attached to the base. If the display (E-bike computer) becomes disconnected from the base during a ride, the speed of the E-bike will change. Unexpected deceleration may impact your riding conditions and other vehicles near you. Always be prepared to pull off to a safe area in case the display (E-bike computer) becomes disconnected from the base.

Importance of practice & rider training

Before you ride this bike, practice riding in a safe area free from hazards. Take time to learn to bike's controls and performance. Practice the controls and gain the experience necessary to avoid the many hazards you will encounter while riding.

Operating an E-Bike (2 of 4)

WARNING

Riding Enviroments

Improper use of the drive assist system may result in riding at unsafe speeds and cause accidents resulting in serious injury or death. Do not accelerate using the drive assist system in situations where there is a possibility of causing harm to people, animals, or property. Always maintain control of the E-bike and operate at a safe speed.

Riding the E-bike through water could result in loss of control and damage to the drive assist system. Do not ride into, or attempt to ride through, water or sub-merge any part of the E-bike.

The E-bike is heavier than ordinary bikes and may result in tip-over, serious injury, or death if not parked properly. Always park the E-bike in a safe area away from children, animals, and property (e.g. vehicles). Always park the E-bike on a level surface so it cannot tip over.

Always wear an approved bicycle helmet and all other protective gear (e.g., gloves, pads, and cycling shoes).

Importance of practice & rider training - before you ride this bike, practice riding in a safe area free from hazards. Take time to learn the bike's controls and performance. Practice the controls and to gain the experience necessary to avoid the many hazards you will encounter while riding.

Do not ride "hands-off" - Keep your hands on the handlebars when riding the bike. If you remove your hands from the handlebar while riding, you can lose control of the bicycle and crash.

Operating and E-Bike (3 of 4)

WARNINGS

Changing the assistance level while riding: Changing the drive-assistance level while riding will increase or decrease the acceleration of the bike. You should anticipate this change in speed and react appropriately depending on the riding conditions such as on slippery trails, tight turns, or unstable or uneven surfaces. Set assistance level to "eco" (lowest assist) or to "off" before descending technical trails, (e.g., tight downhill switchbacks).

When not riding: Turn the drive system off to prevent unauthorized use.

Do not ride the e-bike without the battery. Make sure the battery is fully charged before every ride to help ensure adequate battery power for necessary lighting and for the drive system.

Do not remove any lighting or reflectors and do not ride if they do not work.

Do not allow children to operate or to come into contact with the e-bike or its parts.

Only turn the drive system on when you are seated ready to ride.

Accidental activation: Always disconnect the battery from the bike before working on the bicycle. If you transport the bike by car or by airplane, obey local regulations regarding transporting a bicycle with a drive system battery. Accidental activation of the bicycle drive system can result in serious injury.

Operating and E-Bike (4 of 4)

WARNINGS

Wired system control: If the drive system control device is detached from the mount or if the cables are disconnected or damaged, the drive system will automatically shut off. If this happens, you will have to stop the bike, turn the system off, re-attach the computer to the base, and then turn the system back on to resume operation.

Wireless system control: In wireless control systems, the operation of the drive system is controlled using radio frequencies without physical attachment. Therefore, ON/OFF activation is determined by software programming. Please consult the manufacturer's instructions for information on preventing accidental activation or on restarting the drive system in the event of a recovery from a drive system fault.

Your insurance policies - Your insurance policies (e.g., liability, property, and injury) may not provide coverage for accidents involving the use of this bicycle. To determine if coverage is provided, you should contact your insurance company or agent. Also, make sure your speed e-bike is insured and registered according to the local laws.

Ride sensibly and safely around others - the application of power by means of the electric motor assist means that riders can reach high speed. Riding faster increases the risks of serious accidents.

Watch out for other vehicles, cyclists, pedestrians, and animals where you ride. Always operate under control and at a safe speed. Others may not be aware of you. It is your responsibility to anticipate and to react to avoid accidents.

E-bikes are heavier than ordinary bikes - always park the bike in a suitable safe area away from children, cars or animals that may come into contact with it. Park the bike so that it cannot fall over and possibly result in injuries.

Do not ride into or attempt to ride through water or to submerge any part of the bike. If you ride through water you can lose control of the bike or the drive-assist system can become disabled or damage.

You can be severely injured, paralyzed, or killed in an accident if you ignore these warnings.

E-Bike Batteries & Chargers (1 of 3)

WARNINGS

Failure to observe the following warnings could result in electrical fires, explosion, severe burns or electrocution.

The battery and battery charger contain hazardous materials. Always keep the battery and battery charger away from children, animals, or persons incapable of understanding the potential hazards.

The battery and battery charger contain no serviceable parts.

Do not open, disassemble, or modify the battery or charger.

Improper handling of the battery and battery charger may result in electrical fires, explosion, severe burns or electrocution.

Do not move the battery or battery charger during charging

Do not hold the battery charger during a thunder or lightning storm

Do not plug or unplug the battery charger with wet hands

Do not place any items on the battery charger, or cover ventilation.

Do not place the battery charger in any wet or damp location.

Overcharging the battery could result in electrical fires, explosion, or severe burns. Always disconnect the battery from the battery charger when the battery is fully charged. Unplug the battery charger from the wall outlet when not in use.

A damaged battery or battery charger (e.g. cable, plug or housing) may result in leakage of hazardous materials or be a potential source of sparking and fire. Always examine the battery and battery charger before each use. Never charge a damaged battery or use a damaged battery charger.

Battery/Charger Compatibility: Charging the battery with an incompatible battery charger may result in electrical fires, explosion, severe burns or electrocution. Only charge the battery using the battery charger that came with your bike, or one specified by the manufacturer's instructions. Never use the battery charger to charge any other batteries.

E-Bike Batteries & Chargers (2 of 3)

WARNINGS

Charging Environment

Locate both the battery and battery charger indoors, in a clean, dry area with good ventilation to charge. Always place the battery and battery charger on an even surface. Ensure the area is free from dust, moisture, combustibles and keep the battery charger ventilation openings unobstructed. If applicable, always turn the power switch on the battery OFF before attaching.

Contact between the battery contacts and metal objects such as paper clips, coins, keys, nails, screws or other metal items could result in shorting out the battery and cause electrical fires, explosion, or severe burns.

Transportation

The battery is subject to hazardous materials regulations when in transit. Always contact the proper authorities regarding the requirements to transport the battery. Do not transport the battery without insulating the battery contacts, properly packaging the battery, applying required safety labels, and use of an authorized shipping container. Never transport a damaged battery.

The battery must be removed from the e-bike before transporting the bike on an aircraft. Always contact the air carrier for specific requirements.

Disposal

The battery and battery charger contain regulated materials and must be disposed/discarded in accordance with national and/or local laws. Do not discard the battery and battery charger into fire, water or ordinary household waste/garbage. Always dispose the battery and battery charger at an approved waste facility/recycler.

E-Bike Batteries & Chargers (3 of 3)

WARNINGS

Storage

Unexpected activation of the drive assist system could result in serious injury or death. Always turn OFF the drive assist system, remove the key, and remove the battery from the e-bike when storing the bike. Place the parts in a secure location.

Overheating of the battery could result in electrical fires or explosion. Always store the battery and battery charger in a well-ventilated area at moderate temperatures.

E-Bike Drive System Maintenance

WARNINGS

There are no user serviceable elements incorporated into the motor, motor controller, battery, battery charger, throttle, or wiring harness of your e-bicycle. **DO NOT ATTEMPT TO DISASSEMBLE OR ADJUST ANY OF THESE COMPONENTS.** Doing so may cause extensive damage to these components, will void your warranty, and may cause a hazardous condition.

If you cannot resolve a problem, contact:

1-800-BIKE-USA

Performing maintenance on the e-bike with the drive assist system active could result in accidental activation of the drive assist system. Always remove the battery from the e-bike before performing maintenance.

Cleaning 'live' electrical components may result in shock, sparks, physical personal injury and damage to the electrical component(s). Always de-energize the electrical components (e.g. battery, display) before cleaning.

E-Bikes - Restricting Use

WARNINGS

Use of this e-bike by persons (including children) with reduced physical, sensory or mental capabilities or persons lacking experience and knowledge in the use of the e-bike could result in serious injury or death.

The owner of this e-bike must ensure this product is not used by people with the conditions described above. Always follow the rules, regulations and laws (including age limits) related to the use of an e-bike in its area of use.

A child may not realize or understand the e-bike has moving parts and components (e.g. battery). Never allow children to play or come into contact with the e-bike or its parts. Always follow all rules, regulations and laws regarding age limits and operation in the e-bike area of use.

Required Safety Devices

WARNINGS

Many states require specific safety devices. It is your responsibility to familiarize yourself with the laws of the state where you ride and to comply with all applicable laws, including properly equipping yourself and your bike as the law requires.

Observe all local bicycle laws and regulations.

Observe regulations about bicycle lighting, licensing of bicycles, riding on sidewalks, laws regulating bike path and trail use, helmet laws, child carrier laws, special bicycle traffic laws.

It's your responsibility to know and obey the laws.

No Modifications

WARNINGS

DO NOT physically alter your frame in any way.

Don't sandblast, shot blast or glass bead your frame.

Don't use any coarse sandpaper on your bike.

Don't grind, wire brush, file, scrape or machine buff your frame.

Don't weld, braze or let anyone touch your frame with a torch. Don't drill any holes in your frame. Don't acid dip or etch your frame.

Don't anodize or chrome plate your frame. Any of these procedures will seriously harm the structural integrity and/or longevity of your frame, which could lead to serious accident and injury. Modifications will void any applicable warranty.

Modifying the E-bike and drive assist system could result in damage to the drive system, faulty or dangerous operating conditions, or violation of rules, regulations and laws related to the use of an E-bike. Never modify the E-bike or its parts for any reason.

Attempts to “hot-rod” or “improve” the speed of the bike can be dangerous to the rider. Only use specified drive-assist service and replacement parts. Failure to do so may void the product warranty.

Follow Laws & Regulations

See also, Bike Model Specifics, "Frame Labels."

WARNINGS

You must obey all local laws & regulatory requirements - it is your responsibility to identify and follow all local laws and regulations necessary for legal compliance. Compliance with local regulation is critical to the safety of a rider and others where the bike is used.

Here are some important specifications related to compliance with local laws:

Vehicle class - a definition (California, usa) of the different types of e-bikes, e-bike labeling and legal use areas, including any required additional equipment, registration, and applicable rider age restrictions.

Vehicle category - a definition of the european union of the different types of e-bikes, who and where they may be used, necessary additional equipment such as lighting and signaling devices as well as any necessary insurance and licensing.

Minimum operator age - a minimum age requirement for a rider of the e-bike. This restriction as well as speed and additional equipment requirements (light, helmets, license plates, signal lamps, etc.)

Follow any state or local laws for any minimum age restrictions for e-bikes in your area.

Your Insurance Policies

Your insurance policies (e.g. liability, property and injury) may not provide coverage for accidents involving the use of this E-bike. To determine if coverage is provided you should contact your insurance company or agent.

Kickstands

WARNINGS

If the bike is equipped with a kickstand:

- (1) Improperly installing a kickstand could result in the bike being unstable when parked and tipping over.
- (2) A kickstand must only be installed by a professional bike mechanic.
- (3) Riding with the kickstand in the down position may result in unexpected contact with the ground or other objects causing loss of control.
- (4) Always ensure the kickstand is in the up position and securely locked in place before riding the bike.
- (5) Sitting on the bike with the kickstand down may result in the bike tipping over. Never sit on the bike when it is only supported and stabilized by the kickstand. The kickstand is not designed to support the weight of a person.

Trailers

WARNING

Riding with a bike trailer that is incompatible with the bike could create dangerous riding conditions.

Always confirm with the bike trailer manufacturer the bike trailer is compatible with the bike before attaching a bike trailer and riding. Consult with a professional bicycle mechanic about trailer attachment.

Racks

WARNING

Improperly installing a rear rack could result in a bike being unstable when carrying weight and create dangerous riding conditions.

Overloading a rear rack could create dangerous riding conditions. Always observe the maximum weight limit stated by the rack's manufacturer. Never overload the rear rack. An improperly secured load on a rear rack could create dangerous riding conditions. Always ensure the load on the rear rack is properly secured before riding.

Child Carriers

WARNINGS

Child carriers add weight and raise the center of gravity, making balance and cornering more difficult. If you lose control, you and your child passenger can be severely injured or killed.

We urge you NOT to install child carriers on bicycles. If you choose to install a child carrier, have an experienced bicycle mechanic install it. Install only on a compatible bicycle. If you insist on using a child carrier we urge that you confirm with both the carrier rack manufacturer and the child carrier manufacturer that the two products are safely compatible. Always use caution when riding with a child carrier.

Some saddles are equipped with coil springs. If you use a rear rack mounted child carrier there is a risk that a child's fingers could be injured if trapped in the coil springs when the rider hits a bump and the springs compress. Be sure that the child cannot reach the springs when properly strapped in the carrier.

We encourage use of trailers or bicycles specially designed for carrying children. Be very careful when towing a trailer. Remember that braking distances increase, and the trailer will track inside the line of the bicycle when making turns. Children should always wear helmets when riding in a child carrier or trailer. Use of bicycle helmets on children is required by law in many areas.

Distracted Attention

WARNING

DISTRACTED ATTENTION: Do not allow any accessories to distract your attention or to impair your ability to operate your bicycle safely.

Do not stare at electronic devices (e.g., light controls, iPhones, Android phones, lighting system, remote cameras, or cycling computers) while you are riding. Distractions will take your attention away from the important tasks of riding your bicycle.

Fully stop your bike in a safe place away from traffic before adjusting, changing modes or otherwise interacting with the App, or any other controls."

Foreign Objects Are Very Hazardous

WARNINGS

Do Not Ride Over Sticks Or Debris (Foreign Objects).

We are aware of rare but very serious accidents where a foreign object was kicked up, entered the spokes of the front wheel, was swept around and either broke the fork or stopped the wheel. The forensic evidence was clear, even if the object itself could not later be located.

See "Inspect for Safety" for some information on how frame and fork materials can be broken.

Avoid Riding Over Sticks, Debris:

The riders were taken by surprise and crashed hard. As many riders know, the road side can be littered with a great variety of debris. Common items are sticks, branches, auto parts and trash.

Be Aware Of The Path Ahead, To Avoid:

Scan ahead and if you see debris ride around it. Before moving from your predictable path of travel, look over your shoulder to be sure you can do so safely. If you are riding with a group and at the front, point out debris.

RIDING OVER OR INTO DEBRIS COULD LEAD TO AN ACCIDENT, WITH RISK OF SERIOUS INJURY, PARALYSIS OR DEATH.

Running or "Be Seen" Lights

WARNINGS

Some urban, city, commuter bicycle models have built in, integrated daytime running lights or "be seen" lights.

Intended use: these lights are intended to be daytime running lights. They are intended to draw attention to you while riding and increase the chance of other cyclists, pedestrians and motorists seeing you. They are "be seen" lights, not lights designed to illuminate the road or hazards in the road.

Not intended: because these lights are not as bright or intense, they are not a replacement for higher intensity lights intended to illuminate the road or hazards in the road.

While riding: stop before changing the operating mode.

Higher risks riding at night: the risk of an accident, particularly being struck by a motor vehicle, is much higher at night. If you choose to accept this risk, improve your odds: always use a proper lighting system made up of a headlight and tail light, and a strobe light. Wear light colored reflective clothing. Ride cautiously. Seek the advice of an experienced bicycle commuter at your retailer. See warnings in part ii, section a, riding at night, dusk, dawn.

Any lighting system can fail without warning.

Ride cautiously at night. Many experienced cyclists use two lighting systems, one helmet mounted, one mounted on the bicycle.

Do not remove the reflector system from your bike.

YOU CAN BE SEVERELY INJURED, PARALYZED OR KILLED IN AN ACCIDENT IF YOU IGNORE THESE WARNINGS.

Maximum Fork Length

Maximum Fork Length is an important frame safety testing specification for front suspension mountain bikes. You must observe the measurement when installing headset parts, headset adapters, installing and adjusting a fork, and selecting replacement forks.

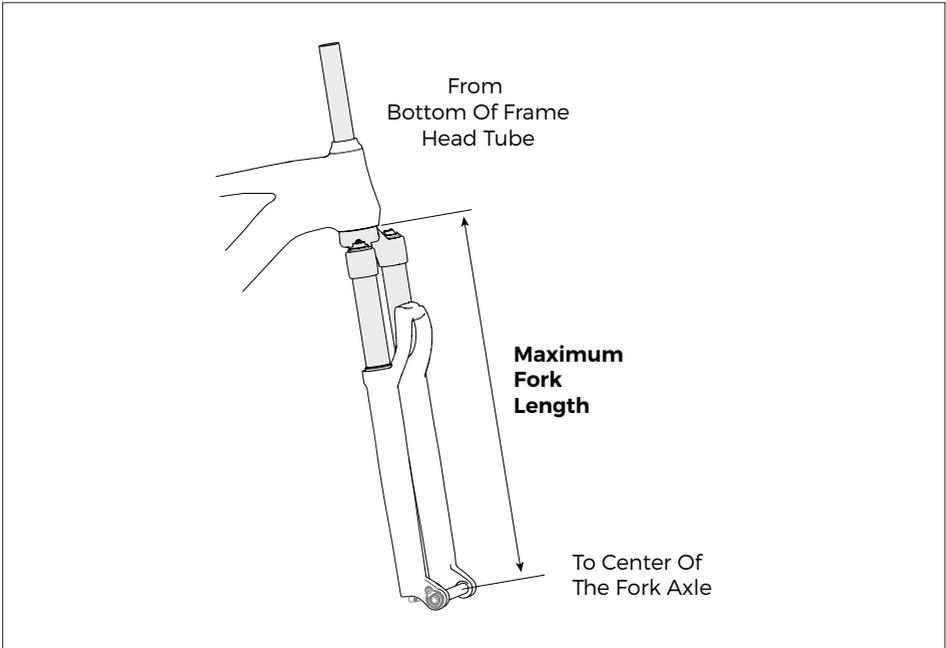

WARNING

You must select a replacement fork not only based on head tube diameter but the critical factor of frame maximum fork length.

Do not exceed maximum fork length. Exceeding the MAXIMUM FORK LENGTH limit can overload the frame causing it to break while riding.

Your retailer MUST follow and observe this specification for your bike. For Maximum Fork Length specifications for GT bicycles, see www.gtbicycles.com.

You can be severely injured, paralyzed or killed in an accident if you ignore this warning.

Rear Tire Clearance : Full Suspension

Applies to:

- saddles
- seat posts
- rear racks
- Dropper posts
- any accessory with possible collision with the moving tire.

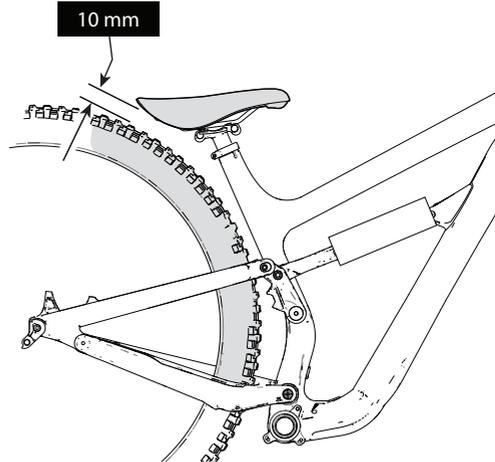

To check clearance:

1. Release all the air from the rear shock. Remove the coil spring from coil shocks. spring coil (removal should only be done by a professional bike mechanic). Do not disconnect or remove the shock.
2. Compress the suspension fully with the tire inflated to its maximum inflation pressure.
3. At various points across the tire, measure the distance between the tire and the component or accessory.
4. If there is less than 10 mm of clearance available, the component or accessory must be adjusted or changed until there is at least 10 mm of clearance.

WARNINGS

Maintain 10 mm of clearance between rear tire, any rear rack, saddle, seat post, frame seat tube, or any mounted accessory.

Check following saddle or seat post adjustments.

If you have questions maintaining tire clearances for parts of your bike consult with an Authorized Dealer or a professional cycling mechanic.

You can be severely injured, paralyzed or killed in an accident if you ignore this warning.

Refinishing

WARNING

We know that bike owner's refinish and repaint bikes. No owner's manual or voided warranty will prevent this.

We can't predict all the things that could go wrong in the refinishing process.

What we hope to communicate to you in the form of this warning is that:

1. Incorrectly refinishing or repainting your bike can lead to a serious accident.
2. Refinishing could hide structural damage (fatigue cracks, dented or bent tubes, or other structural problems) also leading to an accident. You can be injured or killed.

PRECAUTIONS:

- Chemicals that might be used in refinishing might attack your frame and/or fork (carbon fiber) and weaken them.
- Removing original paint, decals (sanding, scouring, scratching, or blasting) can actually remove frame material possibly weakening them.
- Refinishing can not fix structural problems; refinishing might conceal serious damage.

IF YOU DECIDE TO REFINISH: (suggestions)

- Understand that your GT limited warranty will be voided
- Go to a professional bicycle re-painter (often a frame builder).
- Ask about the professional's experience with aluminum and/or carbon frames.
- Be sure your frame is never sanded with paper coarser than 150 grit.

Bicycles Have Sharp Surfaces

WARNING

Bicycles have exposed sharp surfaces.

Exercise caution with chainrings and pointed, aggressive platform pedals, as they have sharp and potentially dangerous surfaces. Use caution when working on your bike. If you slip or fall you could be injured.

Bar Ends

We urge consumers not to install "Bar Ends" on bicycles. Some handlebars are designed to take the added stress of bar ends, others are not. Very lightweight handlebars may be particularly poorly suited for bar ends. If you want bar ends, consult your authorized dealer about suitable choices, read and follow instructions and warnings that accompany the handlebars and bar ends, and inspect the handlebars and bar ends regularly.

Installing Accessories

Have all accessories mounted by your authorized dealer. Be sure that any accessory you or your authorized retailer fits to your bike does not block or interfere with nationally required reflectors or lights.

WARNING

Incompatible accessories or poorly or improperly mounted accessories can adversely affect the performance of your bicycle and may be unsafe.

Aerodynamic Handlebars

Aerodynamic or "Triathlon" handlebar extensions are fitted to some triathlon or racing bikes. They are also added by customers. Understand that when riding on these extensions your steering and braking are adversely affected. When on the extensions, most riders find it hard to look back over their shoulder without swerving, inadvertently steering. Some riders find it harder to move their head/neck to see forward. Be sure to practice riding with aero handlebar extensions on hazard and traffic free roads. Practice the transition from having your hands on the extensions to having your hands on the regular handlebars and brake levers.

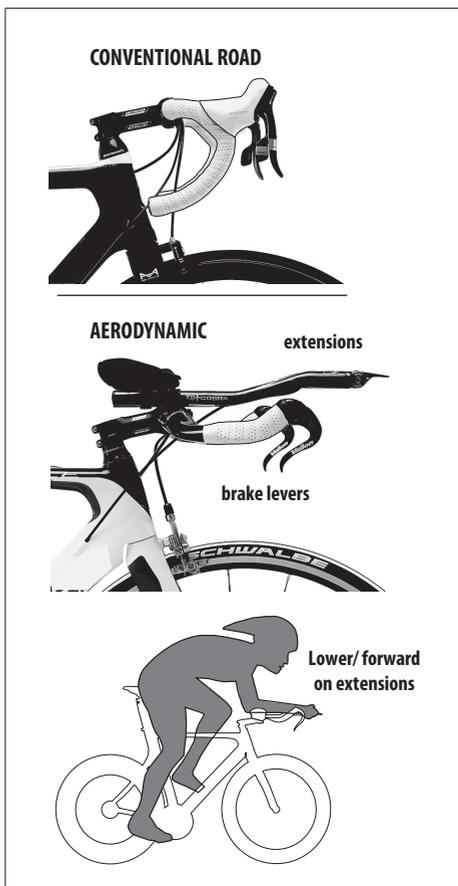

 **WARNING**

Do not ride on the aero handlebar extensions in traffic or on difficult roads.

Ride on the aero handlebar extensions only when the road is clear of traffic and hazards and you have a long line of sight.

When using the extensions understand that you are compromising steering and braking in favor of speed. If you need to take evasive steering or braking action while on the extensions you could have an accident, with risk of serious injury, paralysis or death.

Aerodynamic handlebars and extensions are a design trade-off which positions you further forward than on a conventional road bike, so:

Overly hard use of the front brakes will pitch you forward, off the bike, more easily.

Rear braking performance will not equal that of a conventional road bike.

When braking hard on any bike, including time trial or triathlon, you must shift weight back to allow front brake use without pitching yourself forward, off the bike. Shifting weight back allows more rear braking effect before the rear wheel begins to skid when braking hard, or braking on a steep downhill. See PART1 Section 4C. of this manual.

Aerodynamic handlebars and extensions are intended for racing and competition in time trial and triathlon and are poorly suited for riding in cities or congested urban areas where conflicts with cars will frequently require panic braking.

About Shimmy

Some cyclists have experienced disturbing "shimmy" or "vibration" at certain speeds. This symptom is rarely reported and there is no agreement among experts as to the cause. Among the proposed causes of shimmy are: a loose headset, frame alignment problems, weight of front wheel magnets for cycle computers, and spoke tension.

Larger riders on larger frames are thought by some to be more likely to experience such vibration.

If you experience such a vibration, gently apply the brakes and slow down. Another suggestion is to press your leg against the top tube as you slow down.

 **WARNING**

If you experience "shimmy," do not ride continue to ride your bike. Take the bicycle to your retailer for inspection, service, or changes.

Toe Overlap or toe clip overlap

What is It?

What is It? "Toe overlap" or "Toe clip overlap" describes the toe of your shoe, your shoe attached to a clipless pedal or your toe clip contacting the front tire (or front fender). This may occur when a pedal is all the way forward and the front wheel is turned sharply to a position where the toe or toe clip can contact the tire (or fender). If you ride with clipless pedals, attach your riding shoes to the pedals and check for front tire clearance. If you ride with toe clips, check for front tire clearance.

"Toe clip overlap" is common on small frame size bicycles. It is simple to avoid any contact with the front tire: have the inside pedal up before beginning a turn. As you turn to the left, the inside (left) pedal should be positioned at twelve o'clock. As you turn to the right, the inside (right) pedal should be positioned at twelve o'clock. Having the inside pedal up will prevent any toe clip-to-tire contact and maximize cornering ground clearance. Learn to make it your habit on any sized bike

Whether or not you have overlap, or how much overlap you have can be changed. Be aware that toe clearance can be increased or decreased by changes in crank arm length, size of pedals or toe clips used, size of tires used, addition of fenders, size/design of shoes worn.

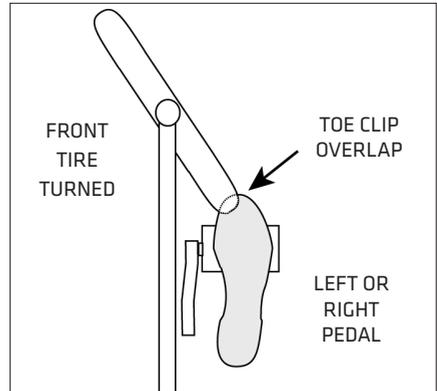

Figure 20.

WARNING

Toe clip overlap could cause you to lose control of your bike, fall and be seriously injured, paralyzed or killed.

Please consult with your retailer on the simple steps you must follow to avoid an accident. Insist that your retailer work with you to determine if your own combination of bicycle, shoe(s) and components have this common design feature.

Tire Size

WARNING

Mounting the wrong size tires can result in the tires hitting the fork or frame when riding. If this happens, you can lose control of your bike and you can be thrown off, a moving tire can be stopped because it touches the fork or frame.

Do not mount oversized tires, ones that rub or hit the fork or frame, ones that result in too little clearance, or ones that can hit the fork or frame when the suspension is fully compressed or when riding.

Take care that the tires you select are compatible with your bike's fork or frame design. Also, be sure to follow the manufacturer's recommendations of your front fork and rear shocks.

When you are considering tires for your bike consider...

The actual measured size of a tire may be different than its sidewall marking. Each time you mount a new tire, take the time to inspect the actual clearance between the rotating tire and all parts of the frame. The u.S. Consumer product safety commission (cpsc) requires at least 1/16" (1.6 Mm) tire clearance from any part of the bike. Allowing for lateral rim flex and a wheel or rim that is out-of-true will likely mean choosing a rear tire that provides even more clearance than the cpsc recommends.

Ask your authorized dealer for the right tires for your bike and its particular components!

You can be severely injured, paralyzed or killed in an accident if you ignore this warning.

Tire & Rim Pressure Compatibility

WARNING

MAXIMUM TIRE PRESSURE MAY BE LIMITED BY RIM DESIGN.

1. ALWAYS check both tire sidewall and rim pressure markings.
2. NEVER inflate tire above maximum rim pressure.

In the rapidly evolving area of disc brake specific lightweight and carbon fiber rims, some rim manufacturers have specified maximum tire pressure.

Of course a customer might choose any tire, and a tire may have a maximum pressure listed on the sidewall that is higher than the maximum pressure listed on the rim. You must never exceed the maximum air pressure marked on the rim.

Excess pressure could lead to rim failure, and an accident, with risk of serious injury, paralysis or death. If you have any doubt or question, contact the rim manufacturer or insist that your Retailer contact the rim manufacturer.

How to Check Wheel Rim Wear

Check the condition of wheel rims wear before every ride.

It is important to your safety, that, you also check the surface wear of the wheel rims (in addition to brake pad wear). This is the area of the wheel where the brake pads contact the rim. Rims can wear out.

How Can You Check Rim Wear?

Some wheels have wear indicators built in. Some indicators are depressions in the rim lower than the surface where the pads touch. When the surface reaches this depression the wheel is worn out. Other indicators are visible markings or signs that are exposed to view when the braking surface is worn out.

Consult the wheel manufacturer's instructions/manuals for information on how to check wear for your specific wheels.

WARNING

Bicycle wheel rims are subject to wear and damage. A worn-out or damaged wheel rim has reached its maximum usable life and must be replaced.

Riding on unusable "worn-out" or damaged wheels can lead to braking or wheel failure.

Replace your wheel when they become worn-out or damaged.

Do not ride your bike when the wheels are damaged or worn-out.

Ask your Dealer for help with inspecting the rim wear of your wheels.

You can be severely injured, paralyzed or killed in an accident if you ignore this message.

Understanding Disc Brakes On Road Bikes

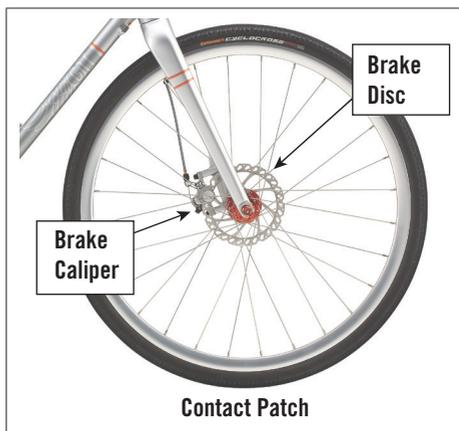

WARNING

Some road bikes are equipped with disc brakes. Relative to conventional rim brakes, disc brakes are less affected by water, do not wear or heat the rims and therefore are more consistent. Disc brakes also may be more powerful.

To minimize risk of injury or accidents:

Understand that road bikes have a relatively small tire contact patch (part of the tire that touches the road). In order to apply the brakes safely and effectively, you may need more or less braking force in different situations. You need to take into account various road and weather conditions that can affect traction.

Disc brakes are excellent, but not some kind of magic. Take some time riding your new disc brake road bike in lower risk circumstances to get used to the feel and performance of the disc brakes and tires.

You can be severely injured, paralyzed or killed in an accident if you ignore this message.

Brake Power Modulators

Your bike may be equipped with a brake modulator, a device installed between the front brake lever and the front brake to reduce initial front braking force. (Brake power modulators are also used on the rear brake of some bicycles.)

If a rider applies the front brake too strongly or too suddenly, these devices can help reduce the risk of locking the front wheel or throwing the rider. Once the modulator device is bottomed out, the front brakes have the same power, and the same risks of overly hard use, as brakes without a modulator. Modulators are a small help in giving a rider more of a chance to react correctly.

Modulators are not a substitute for practicing and learning to brake correctly. See PART I, SECTION 4.C.

WARNING

A brake modulator will not prevent wheel lock up or being thrown off the bike due to overly hard or fast or abrupt application of the brakes.

It is important that you understand modulators are not an intelligent, sophisticated system. Modulators ARE NOT anti-lock braking systems (ABS). Bicycle brake modulators are not like ABS in a car. Unlike automotive ABS there is not an intelligent system of sensors and computer control. Unlike an ABS system in a car you cannot just jam on the brakes and let the system take over. There is no system to think or act for you.

Some people, including sales people, may try to explain brake modulators on bicycles by saying that they are "like ABS". This is misleading and inaccurate.

We urge you to ask your retailer to confirm if you have a brake modulator on your bike. We urge you to ask your retailer to demonstrate how it works. We urge you to work with the front brake lever while standing still to understand how it works. We urge you to read any brake and brake modulator instructions that came with your bike.

Aftermarket Brake Systems

WARNING

Do not modify your bike in any way to mount brakes systems. Mod if cations can damage your bike leading to an accident. You can be severely injured or killed.

Choose only brakes that mount to the frame, swingarm, or fork using only the existing disc brake, v-brake or cantilever mounts. Do not modify the existing mounts or clamp, weld, or in any other way add new or different mounts. Any modification will void the warranty and may weaken or damage the frame. For installation instructions and other warnings, read the literature provided by the brake manufacturer.

When choosing replacements, please ask your authorized dealer have your bike's brakes installed and adjusted by a professional bike mechanic.

Aftermarket Power Systems

WARNING

Do not install a power system (gas or electric type) onto your bike.

Your bike may not have been not designed or intended for use with any type of aftermarket power system.

There are many types of power systems from many different manufacturers. We simply can't predict what all can go wrong by installing one.

We can say that installing an aftermarket power system represents a major modification of your bike. It will change the way your bike handles and fundamentally alter its operation.

When combined with your bike, the power system can be become dangerous to operate.. For example, the brakes may not be adequate for higher speeds.

Riding Off-Road

Off road riding usually involves many, many variables such as constantly changing traction, obstacles, changes in line of sight, up hill, down hill, soft surfaces, dry surfaces and wet surfaces.

Off road riding requires managing a complex and constantly changing rider-to-bicycle feedback loop of traction, weight distribution, application of power, application of brakes and steering driven by the conditions one encounters.

Learning to ride off road is a process. It does not automatically occur because you have a mountain bike or off-road capable bike.

Learning to ride off road does not come from watching "extreme" mountain bike videos or TV. In fact the riders in those films are professional entertainers and/or daredevils, not teachers.

The complexity and ever-changing nature of off road riding requires focus, concentration, strength, fitness and learning to read the trail. The art of managing all this while surrounded by nature makes this a challenging and wonderful sport. We recommend that children not ride on rough terrain unless they are accompanied by an adult.

Here are just some off-road riding concerns:

1. The variable conditions and hazards of off-road riding require close attention and specific skills. Start slowly on easier terrain and build up your skills. If your bike has suspension, the increased speed you may develop also increases your risk of losing control and falling. Get to know how to handle your bike safely before trying increased speed or more difficult terrain.
2. Wear safety gear appropriate to the kind of riding you plan to do.
3. Don't ride alone in remote areas. Even when riding with others, make sure that someone knows where you're going and when you expect to be back.
4. Always take along some kind of identification, so that people know who you are in case of an accident; and take along a couple of dollars in cash for a candy bar, a cool drink or an emergency phone call.
5. Yield right of way to pedestrians and animals. Ride in a way that does not frighten or endanger them, and give them enough room so that their unexpected moves don't endanger you.

6. Be prepared. If something goes wrong while you're riding off-road, help may not be close.

 **WARNING**

Off-road riding is very different from riding a bike on the road. For starters, it is almost certain you will fall off. Get training! Join a club and find experienced people to teach you. Practice and learn to stay in control. Carefully, progressively, learn to expand your limits, but always ride within them.

Off-Road Respect

Obey the local laws regulating where and how you can ride off-road, and respect private property. You may be sharing the trail with others — hikers, equestrians, other cyclists. Respect their rights. Stay on the designated trail. Don't contribute to erosion by riding in mud or with unnecessary sliding. Don't disturb the ecosystem by cutting your own trail or shortcut through vegetation or streams. It is your responsibility to minimize your impact on the environment. Leave things as you found them; and always take out everything you brought in.

About Bicycle Suspension

Suspension will increase the handling capabilities and comfort of your bicycle. This enhanced capability may allow you to ride faster, particularly on rough or bumpy surfaces. As common sense tells you, increased speed brings increased risk.

 **WARNING**

Do not confuse the built-in capabilities of a suspension bike with your own capabilities, which must be learned.

Increasing your skill will take time and practice. Stay in control, and carefully, gradually learn the feel and handling of your suspension bike.

When you apply the front brakes on a suspension bike, the front of the bike will fall or dip as weight shifts forward. This is normal. (The front of your car dips when you apply the brakes.) You must learn to anticipate this weight shift and compensate by shifting your body weight back.

Bicycle Reflectors

Bicycle reflectors are designed to pick up and reflect street lights and car lights in a way that may help you to be seen and recognized as a moving bicyclist.

WARNING

Do not remove the front or rear reflectors or reflector brackets from your bicycle. They are an integral part of the bicycle's safety system.

The location and type of each reflector on your bike is required by a national authority, in the US, the US Consumer Product Safety Commission (CPSC). Your bike have: 1. A front mounted forward facing reflector 2. A rear mounted, rear facing reflector, 3. A spoke mounted reflector on each wheel, 4. Front and rear facing reflectors on the left and right pedal.

Check reflectors and their mounting brackets regularly to make sure that they are clean, straight, unbroken and securely mounted. Have your dealer replace damaged reflectors and straighten or tighten any that are bent or loose.

Removing the reflectors may reduce your visibility to others using the roadway. Being struck by other vehicles may result in serious injury or death.

Carbon Fiber Seat Posts

Care And Maintenance

Inserting the Seat Post

Check the seat tube (1) opening, and slot (2) carefully for sharp edges or burrs. Anything that can scratch, score, gouge, or cut the seat post can cause serious damage leading to breakage of the seat post.

Sharp edges or burrs can be removed by hand by lightly sanding with a very fine sandpaper (400 grit). The should feel very smooth without jagged edges or nicks.

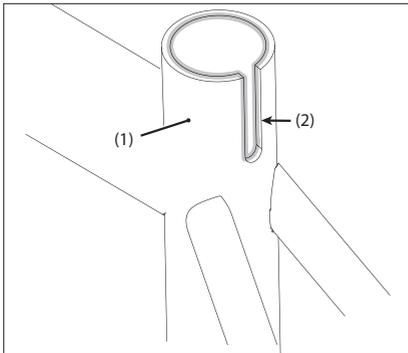

Figure 32.

1. Make sure the seat post, seat binder, and seat tube are clean.
2. Apply small amount of a carbon seat post gel to seat post surface. The gel adds desirable friction and minimizes corrosion. It will help keep your seat post in place.
3. Position the seat binder on the seat tube with the binder slot (A) opposite the seat tube slot (b). Locating the binder slot opposite the seat tube slot reduces the chances of cracking from deformation or accidental overtightening.
4. Insert the seat post and tighten the seat binder to the specified torque with an accurate torque wrench. Consult the seat post manufacturer's instructions for torque information.
5. Check tightening torques of the saddle to seat post clamp bolts. Too much torque may break the bolts. Too little torque will result in movement which leads to fatigue and bolt breakage.

Periodic Seat Post Inspection

Frequent seat post checks are necessary to identify the problems that can lead to an accident. Regularly or in conjunction with your regular bike maintenance routine, do the following:

1. Remove the seat binder from the frame seat post. Clean the binder, the seat post, and inside the seat tube. Use a clean dry towel. Do not use solvents.
2. Carefully inspect the seat post for damage (e.g., cracks, scratches, scrapes, gouges, splintering). If the seat post is damaged in any way, (cracks, scratches, scrapes, gouges, splintering), do not ride it; discard it. Replace it with a new one.
3. Always properly torque saddle to seat post clamp bolts. Too much torque may break the bolts. Too little torque will result in movement which leads to fatigue and bolt breakage.

WARNING

To avoid seat post or frame damage:

1. **FOLLOW THE SEAT POST MANUFACTURER'S INSTRUCTIONS** If you do not have the manufacturer's instructions for your seat post, obtain and read them before using the seat post.
2. **INSPECT AFTER ANY CRASH, FALL, OR IMPACT** - Remove and inspect the seat post for damage (eg., cracks, scratches, scrapes, gouges, splintering). If you find damage, replace it with a new one. **STOP RIDING A DAMAGED SEAT POST IMMEDIATELY GO TO PART II, Section D. Inspect For Safety.** Read "Understanding Composites" for information on carbon fiber
3. **NEVER FORCE A SEAT POST INTO THE SEAT TUBE.** The seat post should always be a slide fit. If the seat post is difficult to install, there is a serious problem. Do not shorten or cut a seat post. Ask your Authorized GT Dealer for help in properly fitting and adjusting your seat post.

continued following pages . . .

WARNING

4. KEEP THE SEAT POST'S "MINIMUM INSERT" BELOW THE TOP OF THE SEAT TUBE.
5. USE A TORQUE WRENCH TO TIGHTEN SEAT POST BINDER AND ALL SADDLE MOUNTING FASTENERS.
6. NEVER USE LIGHT OR SPRAY OILS TO LUBRICATE A SEAT POST OR INSIDE THE SEAT TUBE. Never use solvents, or chemical spray cleaners to clean the inside of the seat tube. Wipe out the seat tube with a clean dry towel only. Light oils (WD40 and oils typically used in honing) and solvents, and including chemical cleaners can attack and weaken composite bonds holding the frame together leading to breakage. Follow the seat post and frame manufacturer instructions.

You can be severely injured, paralyzed or killed if you ignore these warnings.

Seat Post Insert Limit

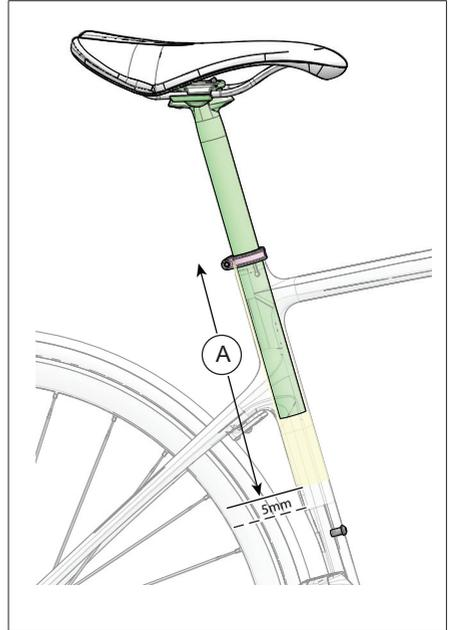

Figure. Seat Post Insert Limit

What is it?

Some frames have designs that limit (B) how far into the frame the seat post can be inserted.

Such a seat post insert limitation is a physical limit and will affect seat posts made of any material.

Such a seat post insert limit will be marked on the frame, via a frame decal and/or in the owner's manual supplement as "seat post insert limit" in the Geometry/Specifications section.

How does it affect my bike?

The seat post must not be forced beyond the limit depth. Attempting to insert the seat post beyond the limit can damage the seat post and/or frame.

To fit some riders who require a lower seat it may be necessary to cut the seat post. This must be done by a professional mechanic who will: Carefully measure, Cut with the proper tools, Smoothly finish the new lower edge of the shortened seat post, Re-mark the CPSC required minimum insertion line on the seat post, Install with the proper lubricant or carbon gel.

WARNING

DON'T CUT A SEAT POST YOURSELF.

If the seat post requires cutting, have it done by a professional bike mechanic with experience cutting high performance carbon or alloy components..

This will help ensure that:

1. The seat post is cut properly.
2. The seat post adjustment range in the frame is correct and the saddle height fits you
3. The seat post is correctly re-marked with its "MINIMUM INSERT."

You can be severely injured, paralyzed or killed if you ignore this warning.

Frame Minimum Seat Post Insert Depth

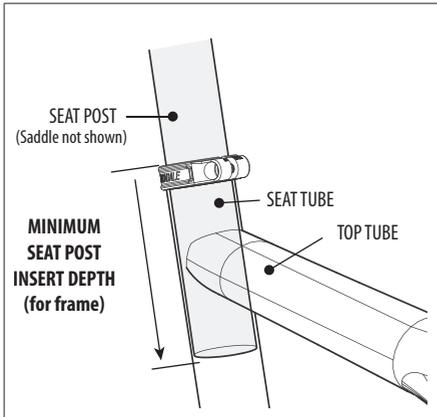

Figure. Seat Post Minimum Insert

What is it?

Some frames have designs that require no less than a specified length of the seat post to be inserted inside the frame. This requirement is more common on high performance carbon fiber mountain bikes, but can exist for other designs. The frame and the seat post work together, support each other. Inadequate overlap of these parts can lead to failure in high load situations.

Such a minimum seat post insert limit will be marked on the frame, via a frame decal and/or in the owner's manual supplement as "minimum seat post insert" in the Geometry/Specifications section.

How Does It Affect My Bike?

You must always have at least the required minimum length of seat post inserted inside the frame.

WARNING

If your frame has a minimum seat post insert depth, make sure the specified length seat post is installed inside the seat tube at all times. Ask your Authorized GT Dealer about this specification.

Failure to insert the seat post correctly can improperly stress the frame and/or the seat post causing the frame to break while riding.

YOU MUST ALSO BE AWARE THAT bicycle seat posts are permanently marked by the manufacturer with a "MINIMUM INSERT" line on the seat post itself. You must not rely on this marking as an indication of the proper MINIMUM SEAT POST INSERTION DEPTH.

You can be severely injured, paralyzed or killed in an accident if you ignore this warning.

Carbon Fiber Forks & Stems

Care and Maintenance

WARNING

ALWAYS SEEK PROFESSIONAL SERVICE - Incorrectly installing, adjusting, servicing, or assembling the wrong parts (handlebar stem, compression assembly, brake bolt, spacers and spacer positions) on your bicycle fork can cause serious damage to it. Any failure in the fork, headset, handlebar stem, or compression assembly while riding can cause you to have a serious accident. All adjustments, maintenance, and any changes must be made by your Authorized GT Dealer.

STOP RIDING A DAMAGED FORK & STEM IMMEDIATELY Your fork can be seriously damaged in any crash or impact. Damage can be concealed and requires very carefully inspection by a professional bike mechanic. A damaged fork and/or handlebar stem can fail without warning. Go to PART II, Section D. Inspect For Safety. Read "Understanding Composites" for information on carbon fiber

REPLACE THE FORK WITH A NEW ONE IF THE DROPOUT TABS ARE MISSING OR DAMAGED. The dropout tabs located at the bottom of the fork dropout act as a secondary wheel retention device and can reduce the risk of the wheel disengaging from the fork if the quick release is not correctly adjusted and closed. It is possible for the tabs to become worn out or damaged through repeated wheel installation and removal, car rack use, etc. Do not file, disable or remove the secondary retention devices. If they are damaged or severely worn, replace the fork.

DO NOT MODIFY THE FORK IN ANY WAY. Do not drill holes or install mechanical clamps.

BRAKE NUT ENGAGEMENT The brake mount is the attachment point of the front brake. A correctly size brake bolt (recessed allen nut) must be used to ensure adequate thread engagement (a minimum of 5mm) with the brake caliper mounting post. Ask your Authorized GT Dealer to help you. obtain the correct brake nut.

You can be severely injured, paralyzed or killed in an accident if you ignore these warnings.

continued on following pages . . .

PARTS OF A TYPICAL CARBON ROAD FORK

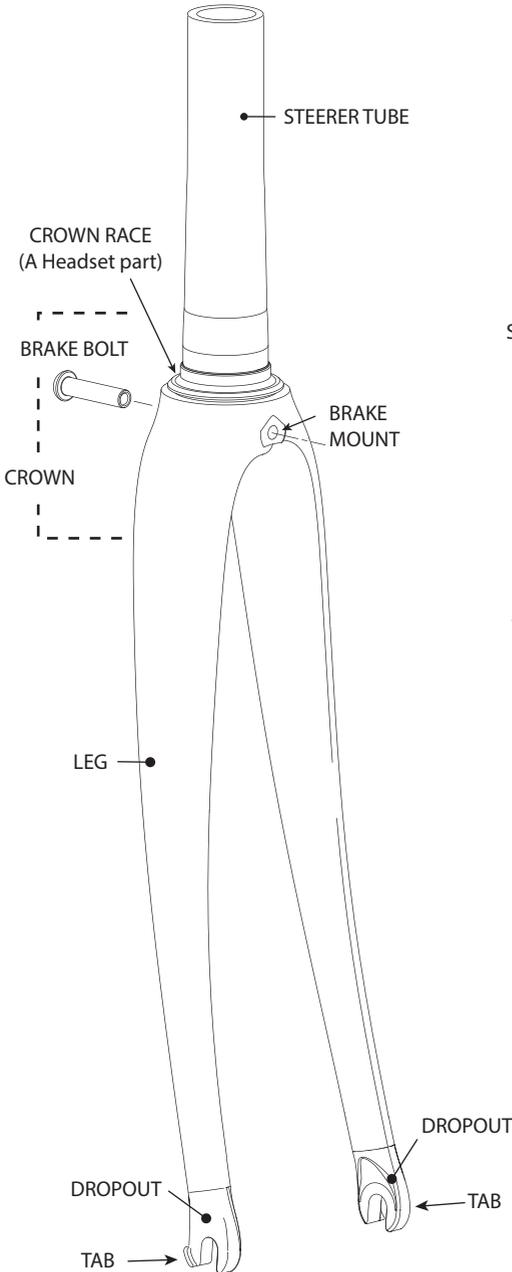

PARTS OF A TYPICAL ROAD STEM

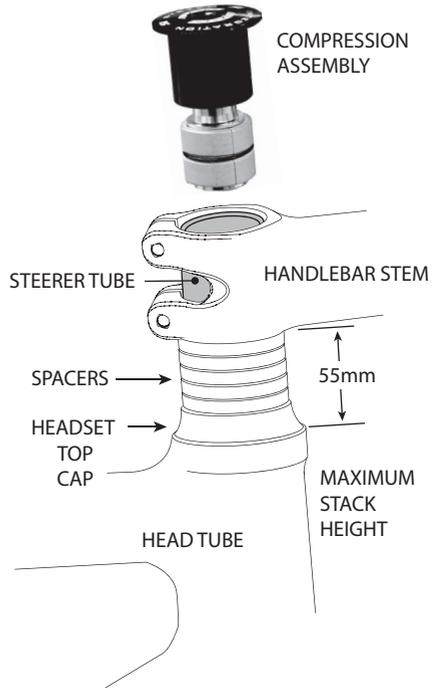

NOTE: Carbon fiber bicycle forks and stems come in many different shapes. The basic parts common to most carbon forks and handlebar stem systems are shown here.

Your fork appearance and shape may vary from what is shown.

If you have any questions about your fork, ask your Authorized GT Dealer.

NOTE: DROPOUTS, STEERER, and HANDLEBAR STEM can be made from carbon fiber, metals or both in a "carbon fiber" fork.

Figure 34

 **WARNING**

DO NOT EXCEED THE MAXIMUM STACK HEIGHT (55mm) OR LOCATE SPACERS ON TOP OF THE STEM. MAXIMUM STACK HEIGHT is a distance spacers may be stacked between the top of the head tube and the bottom of the stem. Exceeding this distance with spacers or locating spacers on top of the handlebar stem can place significant stress on the steerer tube. It could break.

Always tighten fasteners of the headset/stem system and brake with a torque wrench. Observe the manufacturer's torque limits and loctite (thread locking compound) recommendations for each component of the fork, stem, brake and handlebar system. Ask your Authorized GT Dealer to help you. Over-tightening may cause damage and lead to fork or component failure.

For technical information and specifications, see <http://www.gt bicycles.com>

YOU CAN BE SEVERELY INJURED, PARALYZED OR KILLED IN AN ACCIDENT IF YOU IGNORE THESE WARNINGS.

Oem vs. Aftermarket Fork Parts Compatibility

Your bicycle was shipped by GT with a compatible component specification. The fork, the handlebar stem, the headset parts (i.e. spacers, bearings, crown race), and the compression assembly are parts of the system. Other handlebar stems, headset parts, and compression assemblies available to you from sources other than GT may not be compatible.

Aftermarket Handlebar Stems

Many handlebar stem designs from many different manufacturers are available. It is impossible to provide a listing of compatibility based on availability. Don't think availability means compatibility. Here are some factors affecting compatibility:

1. A compatible handlebar stem must be compatible for use with both steerer and handlebar.
2. The stem must be designed for use with carbon forks having an 1 1/8 steerer tubes, without adaptation or alteration of the stem or the steerer tube. The surfaces must mate correctly.
3. The inside diameter of the stem clamping surface must be smooth, free of burrs. It must fit the outside diameter of the steerer tube snugly with the clamp bolts completely loosened. The stem surfaces in contact with the steerer must be smooth, without interruptions (large openings or holes). When clamped to the recommended tightening torque, the stem must not pinch or cause other impressions or cuts in the steerer tube. Smooth and remove any burrs with fine sand paper (220 is ideal).
4. Wedge clamping stems must not be used.

What You Have To Know When Installing Or Adjusting Any Handlebar Stem

The steerer tube length for any GT carbon fiber fork with a carbon steerer is limited to the MAXIMUM STACK HEIGHT of 55mm. This affects the height adjustment of the stem. No spacers may be used on top of a stem. The stack measurement method is shown on the following page. If the steerer tube is cut to accommodate a lesser spacer stack height, please observe the following:

1. Cutting must be done by a professional bike mechanic experienced with carbon components.
2. To produce a straight cut, use a fork cutting jig (e.g., Park Tool SG-6). See http://www.parktool.com/tools/SG_6.shtml.
3. Do not clamp steerer tube directly in vice jaws and/or cut the steerer free hand. Vice jaws can crack or damage the surface of the steerer. Locate the jig on the cut off end of the steerer tube to avoid placing a clamping force on the steerer tube which could produce cracks. Alternatively, you can clamp the steerer in grooved wooden blocks positioned in vice. Do not over-tighten the vice.
4. Additionally, when cutting a carbon steerer tube, use composites hacksaw blade (tungsten carbide gritted) or a very fine toothed (36 toothed) new blade. To minimize fraying of the carbon fibers, wrap the area of cut with masking tape. Make only one clean complete cut. Do not scratch, score, or mark the steerer tube surface other than the complete cut. Scratching, scoring or making other marks on the tube surfaces other than the complete cut, or cutting the steerer tube to an incorrect length for a specific stem/headset can compromise the strength of the steerer tube. After the steerer tube is cut, round the cut edges smooth and remove any burrs with fine sand paper (220 is ideal).

WARNING

We urge you to consult closely with your local Authorized GT Dealer. This will help to make sure that any aftermarket choices you make are compatible with your bike's OEM parts and will not cause serious damage to your bike.

This page has been left blank intentionally.

Section B. Intended Use **WARNING**

UNDERSTAND YOUR BIKE AND ITS INTENDED USE. CHOOSING THE WRONG BICYCLE FOR YOUR PURPOSE CAN BE HAZARDOUS. USING YOUR BIKE THE WRONG WAY IS DANGEROUS.

No one type of bicycle is suited for all purposes. Your retailer can help you pick the "right tool for the job" and help you understand its limitations. There are many types of bicycles and many variations within each type. We make many types of mountain, road, racing, hybrid, touring, cyclocross and tandem bicycles.

There are also bicycles that mix features. For example we have road/racing bikes with triple cranks. These bikes have the low gearing of a touring bike, the quick handling of a racing bike, but are not well suited for carrying heavy loads on a tour. For that purpose you want a touring bike.

Within each of type of bicycle, one can optimize for certain purposes. Visit your bicycle shop and find someone with expertise in the area that interests you. Do your own homework. Seemingly small changes such as the choice of tires can improve or diminish the performance of a bicycle for a certain purpose.

Consult your Authorized Dealer about how you intend to use your bike.

In addition to this section, please consult any Owner's Manual Supplements or components manufacturer's instructions for information on intended use.

Intended Use

Intended Use tables on the following pages contain information from GT, the ASTM International (ASTM), as well as information required by the European Committee for Standardization (CEN). All table information is part of the picture of intended use for your bike.

Conditions 1-4 are part of the ASTM F 2043 voluntary standard in use by the bicycle industry. The tables include the graphic and description text directly from the standard.



Model names listed in the "MODELS" heading includes several recent model years and model variations in component and color. (e.g., SuperSix Team, SuperSix D12, SuperSix RED, SuperSix 105, etc.)

If you have any questions, about intended use or the information presented in the tables, please ask your Authorized Dealer.

For information on the F-2043 ASTM International standard, see <http://www.astm.org>.

High-Performance Road

MODELS

Traffic, Grade, Grade Carbon

Tachyon, Traffic, Baller, Gutterball, GTR Alloy, GTR Carbon, GTS, Corsa, Peace Tour, Strike, Attack, Revenge, EdgeTi, Zum



ASTM Condition 1

"This is a set of conditions for the operation of a bicycle on a regular paved or smooth surface where tires may unintentionally lose ground contact."

Graphic: "Suitable for road riding (only)"

INTENDED

To be ridden on paved roads only.

NOT INTENDED

For off-road, cyclocross, or touring with racks or panniers.

TRADE OFF

Material use is optimized to deliver both light weight and specific performance. You must understand that (1) these types of bikes are intended to give an aggressive racer or competitive cyclist a performance advantage over a relatively short product life, (2) a less aggressive rider will enjoy longer frame life, (3) you are choosing light weight (shorter frame life) over more frame weight and a longer frame life, (4) you are choosing light weight over more dent resistant or rugged frames that weigh more. All frames that are very light need frequent inspection for cracks that would indicate that the frame is worn out from fatigue. These frames are likely to be damaged or broken in a crash. They are not designed to take abuse or be a rugged workhorse.

MAXIMUM WEIGHT LIMIT

* Seat Bag / Handlebar Bag Only

RIDER (lbs/kg)	LUGGAGE (lbs/kg)	TOTAL (lbs/kg)
275/125	10/4.5*	285/126

(continued on next page...)

This page has been left blank intentionally.

General Purpose Riding

MODELS

Air, Slammer, Performer, Fueler, Aggressor, Grade, Grade Carbon, Laguna, Palomar, Transeo, Street Performer, Dyno Pro Compe, Pro Performer, Chucker, Corsa Disc, EdgeCX, Timberline

All Cyclocross (see next page)

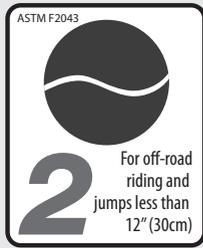

ASTM Condition 2

“This is a set of conditions for the operation of a bicycle that includes Condition 1 as well as unpaved and gravel roads and trails with moderate grades. Contact with irregular terrain and loss of tire contact with the ground may occur. Jumps should be limited to 30cm (12in.) or less.”

Graphic: “For off-road riding and jumps less than 12” (30cm)”

INTENDED

For paved roads, gravel or dirt roads that are in good condition, and bike paths.

NOT INTENDED

For off-road or mountain bike use, or for any kind of jumping. Some of these bikes have suspension features, but these features are designed to add comfort, not off-road capability. Some come with relatively wide tires that are well suited to gravel or dirt paths. Some come with relatively narrow tires that are best suited to faster riding on pavement. If you ride on gravel or dirt paths, carry heavier loads or want more tire durability talk to your dealer about wider tires.

MAXIMUM WEIGHT LIMIT

RIDER (lbs/kg)	LUGGAGE (lbs/kg)	TOTAL (lbs/kg)
300 / 136	30 / 14	330 / 150
Touring/Trekking		
300/136	55/25	355/161

(continued on next page...)

MODELS

All Cyclocross

INTENDED

For cyclocross riding, training and racing. Cyclocross involves riding on a variety of terrain and surfaces including dirt or mud surfaces. Cyclocross bikes also work well for all weather rough road riding and commuting.

NOT INTENDED

For off road or mountain bike use, or jumping. Cyclocross riders and racers dismount before reaching an obstacle, carry their bike over the obstacle and then remount. Cyclocross bikes are not intended for mountain bike use. The relatively large road bike size wheels are faster than the smaller mountain bike wheels, but not as strong.

MAXIMUM WEIGHT LIMIT

RIDER (lbs/kg)	LUGGAGE (lbs/kg)	TOTAL (lbs/kg)
300 / 136	30 / 13.6	330 / 150

Cross-Country, Marathon, Hardtails

MODEL

Air, Slammer, Performer, Fueler, Aggressor, Avalanche, Pantera, Sensor, Sensor Carbon, Zaskar, Zaskar LT

Backwoods, Bump, Karakoram, Marathon, Outpost, Peace 9R, Ricochet, Sensor 9R, Xizang, Zaskar 100, Zaskar AL, Zaskar Carbon, Zaskar LE

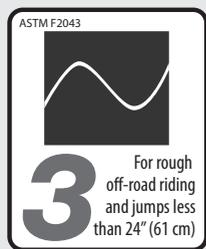

ASTM Condition 3

"This is a set of conditions for the operation of a bicycle that includes Condition 1 and Condition 2 as well as rough trails, rough un-paved roads, and rough technical areas and unimproved trails. Jumps of 60 cm (24 in.) or less are anticipated."

Graphic: "For rough off-road riding and jumps less than 24" (61 cm)"

INTENDED

For cross-country riding and racing which ranges from mild to aggressive over intermediate terrain (e.g., hilly with small obstacles like roots, rocks, loose surfaces and hard pack and depressions). There are no large "sick drop" or drop offs, jumps or launches (wooden structures, dirt embankments) requiring long suspension travel or heavy duty components. Cross-country and marathon equipment (tires, shocks, frames, drive trains) are light-weight, favoring nimble speed over brute force. Suspension travel is relatively short since the bike is intended to move quickly on the ground and not spend time in the air landing hard and hammering through things.

NOT INTENDED

For use in extreme forms of jumping/riding such as hardcore mountain, Freeriding, Downhill, North Shore, Dirt Jumping, Hucking etc.

TRADE OFF

Cross-Country, bikes are lighter, faster to ride uphill, and more nimble than All-Mountain bikes. Cross-Country, trail, and Marathon bikes trade off some ruggedness for pedaling efficiency and uphill speed.

MAXIMUM WEIGHT LIMIT

* Seat Bag Only

RIDER (lbs/kg)	LUGGAGE (lbs/kg)	TOTAL (lbs/kg)
300 / 136	5 / 2.3*	305 / 138

Front suspension frames manufactured w/ original equipment seatstay and dropout rack mounts only.

300 / 136	55 / 25	355 / 161
-----------	---------	-----------

All Mountain, Enduro

MODELS

Distortion, Force AL, Force Carbon, Force LE, Sanction, , Sensor X
Team, Force, Force Carbon,



ASTM Condition 4

“This is a set of conditions for operation of a bicycle that includes Conditions 1,2, and 3 and downhill grades on rough trails as speeds in excess of 40km/h (25 mph) or extreme jumping or both. Use of a bicycle in these conditions is strongly dependent on rider experience and skills.”

Graphic: “For extreme off-road riding”

INTENDED

For trail and uphill riding. All-Mountain bicycles are: (1) more heavy duty than cross country bikes or trail bikes, but less heavy duty than Freeride bikes, (2) lighter and more nimble than Freeride bikes, (3) heavier and have more suspension travel than a cross country bike, allowing them to be ridden in more difficult terrain, over larger obstacles and moderate jumps, (4) intermediate in suspension travel and use components that fit the intermediate intended use, (5) cover a fairly wide range of intended use, and within this range are models that are more or less heavy duty. Talk to your retailer about your needs and these models.

NOT INTENDED

For Hardcore Freeriding, Extreme Downhill, Dirt Jumping, Slopestyle, or very aggressive or extreme riding.

TRADE OFF

All-Mountain bikes are more rugged than cross country bikes, for riding more difficult terrain. All-Mountain bikes are heavier and harder to ride uphill than cross country bikes. All-Mountain bikes are lighter, more nimble and easier to ride uphill than Freeride bikes. All-Mountain bikes are not as rugged as Freeride bikes and must not be used for more extreme riding and terrain.

MAXIMUM WEIGHT LIMIT

* Seat Bag Only

RIDER (lbs/kg)	LUGGAGE (lbs/kg)	TOTAL (lbs/kg)
300 / 136	5 / 2.3*	305 / 138

Gravity, Downhill, Freeride, MTBMX, Dual Slalom, 4X

MODELS

Fury AL, Fury Carbon, La Bomba, Ruckus, Ruckus DJ, Sanction

Fury, Force Carbon, Force TR, Force XR, La Bomba



CONDITION 5

Bikes designed for jumping, hucking, high speeds, or aggressive riding on rougher surfaces, or landing on flat surfaces. However, this type of riding is extremely hazardous and puts unpredictable forces on a bicycle which may overload the frame, fork, or parts. If you choose to ride in Condition 5 terrain, you should take appropriate safety precautions such as more frequent bike inspections and replacement of equipment. You should also wear comprehensive safety equipment such as a full-face helmet, pads, and body armor.

Graphic: "For extreme riding," "User caution advised"

INTENDED

For riding that includes the most difficult terrain that only very skilled riders should attempt.

Gravity, Freeride, and Downhill are terms which describe hardcore mountain, north shore, slopestyle. This is "extreme" riding and the terms describing it are constantly evolving.

Gravity, Freeride, and Downhill bikes are: (1) heavier and have more suspension travel than All-Mountain bikes, allowing them to be ridden in more difficult terrain, over larger obstacles and larger jumps, (2) the longest in suspension travel and use components that fit heavy duty intended use. While all that is true, there is no guarantee that extreme riding will not break a Freeride bike.

THE TERRAIN AND TYPE OF RIDING THAT FREERIDE BIKES ARE DESIGNED FOR IS INHERENTLY DANGEROUS.

Appropriate equipment, such as a Freeride bike, does not change this reality. In this kind of riding, bad judgment, bad luck, or riding beyond your capabilities can easily result in an accident, where you could be seriously injured, paralyzed or killed.

NOT INTENDED

To be an excuse to try anything! Read our "Freeride & Downhill" warning, on page 126.

TRADE OFF

Freeride bikes are more rugged than All-Mountain bikes, for riding more difficult terrain. Freeride bikes are heavier and harder to ride uphill than All-Mountain bikes.

MAXIMUM WEIGHT LIMIT

* Seat Bag Only

RIDER (lbs/kg)	LUGGAGE (lbs/kg)	TOTAL (lbs/kg)
300 / 136	5 / 2.3*	305 / 138

(continued on next page...)

(continued from previous page...)

BMX, Dirt Jump

INTENDED

For man-made dirt jumps, ramps, skate parks other predictable obstacles and terrain where riders need and use skill and bike control, rather than suspension. Dirt Jumping bikes are used much like heavy duty BMX bikes.

A Dirt Jumping bike does not give you skills to jump! Read our "Freeride & Downhill" warning. See page 64. The same message is true.

NOT INTENDED

For terrain, drop offs or landings where large amounts of suspension travel are needed to help absorb the shock of landing and help maintain control.

TRADE OFF

Dirt Jumping bikes are lighter and more nimble than Freeride bikes, but they have no rear suspension and the suspension travel in the front is much shorter.

MAXIMUM WEIGHT LIMIT

RIDER (lbs/kg)	LUGGAGE (lbs/kg)	TOTAL (lbs/kg)
300 / 136	0	300 / 136

SECTION C. **MOUNTAIN BIKE RIDING**

See also Maximum Fork Length.

See also Section B. Intended Use.

Off-Road Riding

Off road riding usually involves many, many variables such as constantly changing traction, obstacles, changes in line of sight, up hill, down hill, soft surfaces, dry surfaces, wet surfaces. Off road riding requires managing a complex and constantly changing rider-to-bicycle feedback loop of traction, weight distribution, application of power, application of brakes and steering driven by the conditions one encounters. The complexity and ever-changing nature of off road riding requires focus, concentration, strength, fitness and learning to read the trail. The art of managing all this while surrounded by nature makes this a challenging and wonderful sport.

If you have ridden your mountain bike on a paved road, or on a gravel or dirt road, you have done very little in the way of learning to mountain bike. Learning to ride off road is a process. It does not automatically occur because you have a mountain bike. Learning to ride off road does not come from watching "extreme" mountain bike videos or TV. In fact the riders in those films are professional entertainers and/or daredevils, not teachers.

WARNING

Mountain bike riding is very different from riding a bike on the road.

For starters, it is almost certain you will fall off. Get training! Join a club and find experienced people to teach you. It is likely that your retailer can hook you up with local rides. Practice and learn to stay in control. Carefully, progressively, learn to expand your limits, but always ride within them.

Bike Types

WARNING

Pick a mountain bike for how you will ride.

There are now many different kinds of "mountain bikes." GT makes mountain bikes ranging from the light, nimble rush and scalpels, designed for cross country (xc) racing, to our rugged, long-travel freeride bikes. A scalpel is not designed for freeride! If you try using your bike for something it was not intended, you may break it with risk of serious injury, paralysis or death.

Matching the intended use of any kind of mountain bike to your expected riding is import.

Read Part 2 Section B. Intended use.

Freeriding & Downhill

WARNING

FREERIDING AND OTHER FORMS OF “EXTREME RIDING” RE EXTREMELY DANGEROUS. YOU CAN BE SEVERELY INJURED OR KILLED IN A SERIOUS ACCIDENT.

Freeriding, jumping, hucking, dirt jumping, mountaincross, downhill, slalom, slopestyle, urban or street riding or other evolving forms of extreme or hard core mountain biking are inherently dangerous and can lead to serious accidents. Wear all safety gear and be sure your bike is in excellent condition. Follow all the instructions and warnings below. These steps will reduce, but not eliminate, the inherent risks. Even with state of the art protective safety gear you could be seriously injured, paralyzed or killed. If you do not want to take these risks, do not engage in this type of riding.

Fundamental Risk

Freeriding, jumping, hucking, dirt jumping, mountaincross, downhill, slalom, slopestyle, urban or street riding. It seems that everywhere you look, from Mountain Dew® commercials to the X-Games® to the Red Bull®Rampage, riders are grabbing big air and sticking sick drops. And it sure looks fun.

But what the videos and bike magazines and ads don't always tell you is that extreme riding takes an amazing amount of skill. Some of the riders you see are well-paid pros who have gradually built up their skills through endless hours of practice, and who have also had their share of stitches, concussions and busted bones (and bikes). Others are daredevils who have chosen to accept or ignore the risks. Would you allow anyone to say that you are so weak in the head, and have such poor judgment that you copy those you see in the media without thought of the serious risks?

The stakes are high if you screw up. Realize too late that you aren't up to the challenge, and you run the risk of major injury or even – say it aloud – death, paralysis. In short, extreme riding carries a high degree of fundamental risk, and you bear the ultimate responsibility for how you ride and what you attempt to pull off. Do you want to avoid these significant risks? Then do not ride this way.

Product Limitations

Problems of pilot error aside, hard-core riding also beats the heck out of your equipment. Although we build and test our bikes to make them tough, there's no way that we can guarantee they'll survive your umpteenth six-foot drop. For starters, there is no industry “jumping” standard. The many circumstances of takeoff, landing, speed, rider technique, etc. are unique. The judgment, lack of judgment or insanity of a rider who may ride a GT bicycle cannot be completely predicted, so it's flat-out impossible to predict how anyone's equipment is going to hold up.

(continued on next page...)

(continued from previous page...)

Let's get another thing straight. Buying a Freeride bike does not make you any better. Do not confuse the built-in capabilities of equipment with your own capabilities, which must be learned.

Keeping your bike and all its components in good working order is critical, and it's up to you to maintain and inspect it. Even so, your sweet rig isn't going to last forever. Nothing does, particularly bikes and parts that are built to minimize weight and then are subjected to abuse. GT frames carry a warranty, but that's to cover issues with workmanship and/or materials. (See the GT Limited Warranty in this manual). The warranty doesn't mean that they're going to last forever. They're not. The warranty certainly doesn't mean that the bicycle can in any way protect you from injury.

Use of Specialized Protective Gear

GT has long urged the use of helmets. As riskier, extreme downhill and freeriding became part of the sport we communicated frankly about the risks in this freeride warning. Given very strong consideration to neck braces, designed for mountain biking and motocross riding, fitted between the rider and helmet, that can decrease the risk of paralysis, spinal cord and neck injuries. As the manufacturer clearly states, these braces cannot prevent all injuries. We urge riders, particularly riders into challenging and risky riding, to investigate and consider prophylactic neck braces (For example, see <http://www.leatt-brace.com/>). A prophylactic neck brace might save your life or keep you out of a wheelchair.

In Conclusion

If you're going hard-core, be smart about it. Always wear a full face helmet, state-of-the-art neck brace, body armor, full-finger gloves, and protective clothing. Choose a bike that's right for you, your riding and terrain, and check it often for signs of fatigue or other trouble. (Your dealer can help you on both fronts.) Read PART II, SECTION B. MOUNTAIN BIKE RIDING. And most importantly, know your limitations. Practice. Stay in control, and carefully, gradually expand your limits – but ride within them.

YOU CAN BE SEVERELY INJURED, PARALYZED, OR KILLED IF YOU IGNORE THIS WARNING.

Suspension

Suspension will increase the handling capabilities and comfort of your bicycle. This enhanced capability may allow you to ride faster, particularly on rough or bumpy surfaces. As common sense tells you, increased speed brings increased risk.

WARNING

Do not confuse the built-in capabilities of a suspension bike with your own capabilities, which must be learned.

Increasing your skill will take time and practice. Stay in control, and carefully, gradually learn the feel and handling of your suspension bike.

When you apply the front brakes on a suspension bike, the front of the bike will fall or dip as weight shifts forward. This is normal. (The front of your car dips when you apply the brakes.) You must learn to anticipate this weight shift and compensate by shifting your body weight back.

Jumping

WARNING

Jumping is very risky. You could have a fall leading to serious injury, paralysis or death.

Jumping a mountain bike is fun, but it puts extreme stress on your bike. Perhaps most vulnerable to jumping-related damage is your fork. Riders who insist on jumping their bikes risk serious damage, to their bicycles as well as themselves.

Stay In Control

WARNING

Failure to ride in control could result in a fall leading to serious injury, paralysis, or death.

While the risks inherent to this sport cannot be eliminated, you can minimize the risks by riding in control and wearing a helmet. The reality is that simple, and that challenging.

Downhill And Lift-Serviced Riding

WARNING

To ride downhill at speed or in competition is to voluntarily assume a very large risk. You could be seriously injured, paralyzed, or killed.

When riding downhill such as at a ski area, on trails or access roads, or on dirt roads such as fire roads, you can reach speeds seen on motorcycles, with similar hazards and risks.

Wear appropriate safety gear, including a full face helmet, full finger gloves, Neck, brace, protective clothing, and body armor. Have your bicycle and equipment carefully inspected by a qualified mechanic and be sure it is in excellent condition. Consult with expert riders and/or race officials on conditions and equipment advisable at any site where you plan to ride downhill. Experienced riders often pre-walk or carefully and slowly pre-ride a downhill course before attempting it at any speed.

Section D. Inspect For Safety

In this section, we will do our best to outline some material science basics and explain how they relate to your bicycle, some of the trade offs made in designing your bicycle, what you can expect from your bicycle and provide important, basic guidelines on how you maintain and inspect it.

Carbon fiber bikes and components are becoming more common.

WARNING

Frequent inspection of your bike is important to your safety. Follow the Pre-Ride Checklist before every ride.

More detailed periodic inspection of your bicycle is important. How often this more detailed inspection is needed depends upon you.

You, the rider/owner, have control and knowledge of how often you use your bike, how hard you use it and where you use it. Because a bicycle mechanic cannot track your use, you must take responsibility for periodically bringing your bike to a qualified bicycle mechanic for inspection and service. This mechanic will help you decide what frequency of inspection and service is appropriate for how and where you use your bike.

For your safety, understanding and communication with a qualified bicycle mechanic we urge you to read this section of the manual in its entirety. The materials used to make your bike determine how and how frequently to inspect.

Ignoring this warning can lead to frame, fork or other component failure, which can result in serious injury or death.

1. Understanding Metals

Steel is the traditional material for building bicycle frames. It has good characteristics, but in high performance bicycles, steel has been largely replaced by aluminum and some titanium. The main factor driving this change is interest by enthusiast customers in lighter bicycles.

Properties of Metals

Please understand that there is no simple statement that can be made that characterizes the use of different metals for bicycles. What is true is how the metal chosen is applied is much more important than the material alone. One must look at the way the bike is designed, tested, manufactured, supported along with the characteristics of the metal rather than seeking a simplistic answer.

Metals vary widely in their resistance to corrosion. Steel must be protected or rust will attack it. Aluminum and Titanium quickly develop an oxide film that protects the metal from further corrosion. Both are therefore quite resistant to corrosion. The 6000 series aluminum alloys in use for years are commonly used in marine applications. Aluminum is not perfectly corrosion resistant and particular care must be used where it contacts other metals and galvanic corrosion can occur.

Metals are comparatively ductile. Ductile means bending, buckling and stretching before breaking. Generally speaking, of the common bicycle frame building materials steel is the most ductile, titanium less ductile, followed by aluminum.

Metals vary in density. Density is weight per unit of material. Steel weighs 7.8 grams/cm³ (grams per cubic centimeter), titanium 4.5 grams/cm³, aluminum 2.75 grams/cm³. Contrast these numbers with carbon fiber composite at 1.45 grams/cm³.

Metals are subject to fatigue. With enough cycles of use, at high enough loads, metals will eventually develop cracks that lead to breakage. It is very important that you read Metal Fatigue 101 next.

Let's say you hit a curb, ditch, rock, car, fallen cyclist or other object. First, read the Important warnings at the beginning of SECTION A: Bicycles Cannot Protect You.

At any speed above a fast walk your body will continue to move forward, momentum carrying you over the front of the bike. You cannot and will not stay on the bike and what happens to the frame and fork is irrelevant to what happens to your body. What should you expect from your metal frame? It depends on many complex factors, which is why we tell you that crash worthiness cannot be a design criteria.

With that important note, we can tell you that if the impact is hard enough the fork or frame may be bent or buckled.

See Figure A on following page. .

On a most all steel bikes, the steel fork may be severely bent and the frame undamaged. Aluminum is less ductile than steel, but you can expect the fork and frame to be bent or buckled. Hit harder and the top tube may be broken in tension and the down tube buckled. Hit harder and the top tube may be broken, the down tube buckled and broken, leaving the head tube and fork separated from the main triangle.

When all metal bikes are crashed you will usually see some evidence of this ductility in bent, buckled or folded metal.

It is now common for the main frame to be made of metal and the fork of carbon fiber. See the composites 101 section below. The relative ductility of metals and the lack of ductility of carbon fiber means that in a crash scenario you can expect some bending or bucking in the metal but none in the carbon. Below some load the carbon fork may be intact even though the frame is damaged. Above some load the carbon fork will be completely broken.

Metal Fatigue 101

Common sense tells us that nothing that is used lasts forever. The more you use something, and the harder you use it, and the worse the conditions you use it in, the shorter its life.

Fatigue is the term used to describe accumulated damage to a part caused by repeated loading. To cause fatigue damage, the load the part receives must be great enough. A crude, often-used example is bending a paper clip back and forth (repeated loading) until it breaks. This simple definition will help you understand that fatigue has nothing to do with time or age. A bicycle in a garage does not fatigue. Fatigue happens only through use.

So what kind of "damage" are we talking about? On a microscopic level, a crack forms in a highly stressed area. As the load is repeatedly applied, the crack grows. At some point the crack becomes visible to the naked eye. Eventually it becomes so large that the part is too weak to carry the same load that, without the crack, it could carry. At that point there can be a complete and immediate failure of the part.

One can design a part that is so strong that fatigue life is nearly infinite. This requires a lot of material and a lot of weight. Any structure that must be light and strong will have a finite fatigue life.

Aircraft, race cars, motorcycles: all have parts with finite fatigue lives. If you wanted a bicycle with an infinite fatigue life, it would weigh far more than any bicycle sold today. So we all make a trade-off: the wonderful, lightweight performance we want requires that we inspect the structure.

In most cases a fatigue crack is not a defect. It is a sign that the part has been worn out, a sign the part has reached the end of its useful life. When your car tires wear down to the point that the tread bars are contacting the road, those tires are not defective. Those tires are worn out and the tread bar says "time for replacement." When a metal part shows a fatigue crack, it is worn out. The crack says "time for replacement."

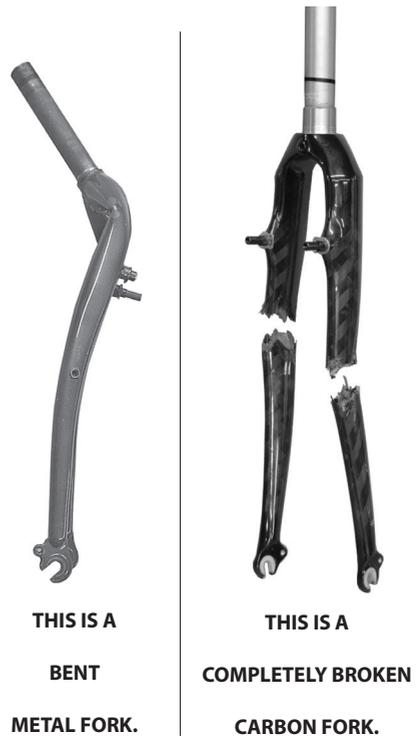
FIGURE A

A few things to think about:

ONCE A CRACKS STARTS IT CAN GROW AND GROW FAST.

Think about the crack as forming a pathway to failure. This means that any crack is potentially dangerous and will only become more dangerous. **SIMPLE RULE 1:** If you find crack, replace the part.

CORROSION SPEEDS DAMAGE.

Cracks grow more quickly when they are in a corrosive environment. Think about the corrosive solution as further weakening and extending the crack. **SIMPLE RULE 2:** Clean your bike, lubricate your bike, protect your bike from salt, remove any salt as soon as you can.

STAINS AND DISCOLORATION CAN OCCUR NEAR A CRACK.

Such staining may be a warning sign that a crack exists. **SIMPLE RULE 3:** Inspect and investigate any staining to see if it is associated with a crack.

SIGNIFICANT SCRATCHES, GOUGES, DENTS OR SCORING CREATE STARTING POINTS FOR CRACKS.

Think about the cut surface as a focal point for stress (in fact engineers call such areas "stress risers," areas where the stress is increased). Perhaps you have seen glass cut? Recall how the glass was scored and then broke on the scored line. **SIMPLE RULE 4:** Do not scratch, gouge or score any surface. If you do, pay frequent attention to this area or replace the part.

SOME CRACKS (particularly larger ones) MAY MAKE CREAKING NOISE AS YOU RIDE.

Think about such a noise as a serious warning signal. Note that a well-maintained bicycle will be very quiet and free of creaks and squeaks. **SIMPLE RULE 5:** Investigate and find the source of any noise. It may not be a crack, but whatever is causing the noise should be fixed before riding.

Fatigue Is Not A Perfectly Predictable Science

Fatigue is not a perfectly predictable science, but we can give you some general factors to help you determine how often you need to inspect (or have your retailer inspect) your bicycle. The more you fit the "shorten product life" profile, the more frequent your need to inspect. The more you fit the "lengthen product life" profile, the less frequent your need to inspect.

Factors that shorten product life:

- Hard, harsh riding style
- "Hits," crashes, jumps, other "shots" to bike
- High mileage
- Higher body weight
- Stronger, more fit, more aggressive rider
- Corrosive environment (wet, salt air, winter road salt, accumulated sweat)
- Presence of abrasive mud, dirt, sand, soil in riding environment

Factors that lengthen product life:

- Smooth, fluid riding style
- No "hits," crashes, jumps, other "shots" to bike
- Low mileage
- Lower body weight
- Less aggressive rider
- Non-corrosive environment (dry, salt-free air)
- Clean riding environment

Aluminum Frame Inspection

1. Clean the bike and remove the wheels.
2. Inspect the whole frame carefully for cracks. Pay particular attention to the underside of the downtube where it intersects the headtube
3. Next carefully inspect the area where the crankset and rear wheel come closest to the right chainstay, particularly on the innermost part of the chainstay and the outermost part of the chainstay. Next look at the welds that join all of the tubes. Be sure to look at the inside of the rear triangle or swingarm while the wheel is out, including the dropouts.
4. Finally check all mounting points such as disc brake caliper brackets and water bottle and rack mounts.

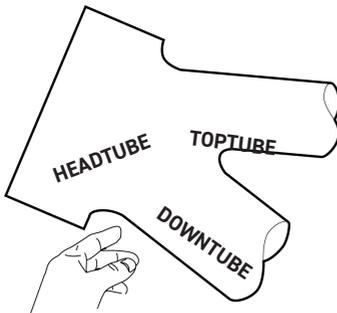

Inspect this area for cracking

Figure 21.

 **WARNING**

Do not ride a frame or fork with any crack, even a small one. Riding a cracked frame or fork could lead to your frame/fork breaking, with risk of accident, serious injury, paralysis or death.

Fork Inspection

1. Remove the front wheel.
2. Clean the fork.
3. Carefully inspect the whole fork for cracks. Pay particular attention to the fork crown area and the area where the dropouts meet the fork blades. Look on the inside of the fork while the wheel is out. Check the area around the brake pivot bosses or caliper mount.

Other Suspension Forks

If you have a fork made by a third party, please read and follow the inspection instructions contained in the manual that covers that fork. If you do not have the third party's manual, get one now.

 **WARNING**

Riding with an improperly secured wheel can allow the wheel to wobble or fall off the bicycle, which can cause serious injury or death. Therefore, it is essential that you:

1. Ask your dealer to help you make sure you know how to install and remove your wheels safely.
2. Understand and apply the correct technique for clamping your wheel in place.
3. Each time, before you ride the bike, check that the wheel is securely clamped. The clamping action of a correctly secured wheel must emboss the surfaces of the dropouts.

See also PART I, SECTION 4. A Wheels.

2. Understanding Composites (Carbon Fiber)

All riders must understand a fundamental reality of composites. Composite materials constructed of carbon fibers are strong and light, but when crashed or overloaded, carbon fibers do not bend, they break.

What Are Composites?

The term "composites" refers to the fact that a part or parts are made up of different components or materials. You've heard the term "carbon fiber bike." This really means "composite bike."

Carbon fiber composites are typically a strong, light fiber in a matrix of plastic, molded to form a shape. Carbon composites are light relative to metals. Steel weighs 7.8 grams/cm³ (grams per cubic centimeter), titanium 4.5 grams/cm³, aluminum 2.75 grams/cm³. Contrast these numbers with carbon fiber composite at 1.45 grams/cm³.

The composites with the best strength-to-weight ratios are made of carbon fiber in a matrix of epoxy plastic. The epoxy matrix bonds the carbon fibers together, transfers load to other fibers, and provides a smooth outer surface. The carbon fibers are the "skeleton" that carries the load.

Why Are Composites Used?

Unlike metals, which have uniform properties in all directions (engineers call this isotropic), carbon fibers can be placed in specific orientations to optimize the structure for particular loads. The choice of where to place the carbon fibers gives engineers a powerful tool to create strong, light bicycles. Engineers may also orient fibers to suit other goals such as comfort and vibration damping.

Carbon fiber composites are very corrosion resistant, much more so than most metals. Think about carbon fiber or fiberglass boats.

Carbon fiber materials have a very high strength-to-weight ratio.

What Are The Limits Of Composites?

Well designed "composite" or carbon fiber bicycles and components have long fatigue lives, usually better than their metal equivalents.

While fatigue life is an advantage of carbon fiber, GT still urges you to regularly inspect your carbon fiber frame, fork, or components.

Carbon fiber composites are not ductile. Once a carbon structure is overloaded, it will not bend; it will break. At and near the break, there will be rough, sharp edges and may be delamination of carbon fiber or carbon fiber fabric layers. There will be no bending, buckling, or stretching.

If You Hit Something Or Have A Crash, What Can You Expect From Your Carbon Fiber Bike?

Let's say you hit a curb, ditch, rock, car, fallen cyclist or other object. First, read the Important warnings at the beginning of PART II Section A. Bicycles Cannot Protect You in this manual.

At any speed above a fast walk, your body will continue to move forward, the momentum carrying you over the front of the bike. You cannot and will not stay on the bike and what happens to the frame and fork is irrelevant to what happens to your body.

What should you expect from your carbon frame? It depends on many complex factors, which is why we tell you that crash worthiness cannot be a design criteria. With that important note, we can tell you that if the impact is hard enough, the fork or frame may be completely broken. See Figure A on page 68. Note the significant difference in behavior between carbon and metal. 1. Understanding Metals in this section. Even if the carbon frame was twice as strong as a metal frame, once the carbon frame is overloaded it will not bend, it will break completely.

Carbon fiber composites are not ductile. Once a carbon structure is overloaded, it will not bend; it will break. At and near the break, there will be rough, sharp edges and may be delamination of carbon fiber or carbon fiber fabric layers. There will be no bending, buckling, or stretching.

Our carbon frames/fork/components are designed for normal riding loads with a factor of safety. These frames/fork/components will be broken by some crash or impact loads.

See "Composite Frame, Fork, And Component Inspection" on next page.

Composite Frame, Fork, and Component Inspection

Cracks:

Inspect for cracks, broken, or splintered areas. Any crack is serious. Do not ride any bicycle or component that has a crack of any size.

Delamination:

Delamination is serious damage. Composites are made from layers of fabric. Delamination means that the layers of fabric are no longer bonded together. Do not ride any bicycle or component that has any delamination. These are some delamination clues:

- A cloudy or white area. This kind of area looks different from the ordinary undamaged areas. Undamaged areas will look glassy, shiny, or "deep," as if one was looking into a clear liquid. Delaminated areas will look opaque and cloudy.
- Bulging or deformed shape. If delamination occurs, the surface shape may change. The surface may have a bump, a bulge, soft spot, or not be smooth and fair.
- A difference in sound when tapping the surface. If you gently tap the surface of an undamaged composite you will hear a consistent sound, usually a hard, sharp sound. If you then tap a delaminated area, you will hear a different sound, usually duller, less sharp.

Unusual Noises:

Either a crack or delamination can cause creaking noises while riding. Think about such a noise as a serious warning signal. A well maintained bicycle will be very quiet and free of creaks and squeaks. Investigate and find the source of any noise. It may not be a crack or delamination, but whatever is causing the noise must be fixed before riding.

 **WARNING**

Do not ride a frame or fork with any delamination or crack. If you ride a delaminated or cracked frame/fork/component it may completely break apart with risk of accident, serious injury, paralysis or death.

Damage caused by a handlebar rotating and striking the top tube is common. The resulting impact cracks and breaks the top tube.

This is not a warranty.

The frame is not safe to ride.

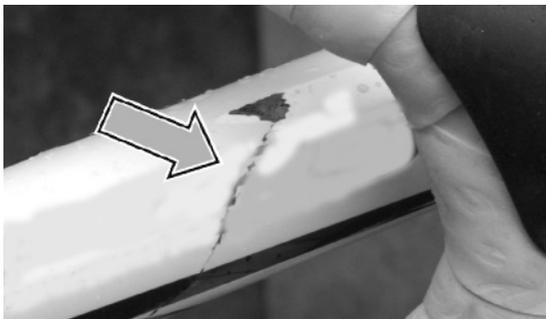

Any impact or crash damage can produce serious damage to the frame. This chainstay was cracked in a crash.

This is not a warranty.

The frame is not safe to ride.



3. Understanding components

It is often necessary to remove and disassemble components in order to properly and carefully inspect them. Most customers will use this component list as a checklist. The intention here is to tell you what parts, and what area of each part, most need inspection. Insist that your mechanic do such inspections. Our intention is definitely not to teach bicycle mechanics.

WARNING

Failure to disassemble or reassemble bicycle components properly could result in an accident, with risk of serious injury, paralysis or death.

There are many special tools and techniques required. Unless you are a very experienced and skilled bicycle mechanic, we urge you to have this work done by a professional bicycle retailer.

If you see any crack, or anything you are unsure of, please take your bicycle to a retailer. If you ride a delaminated or cracked frame/fork/component it may completely break apart with risk of accident, serious injury, paralysis or death.

If you have carbon fiber components, you must read part ii, section d. 2. Understanding composites.

Do not ride any component with a crack, even a small one. Replace the component before riding. Break or saw in half any component you replace so that no one uses it again.

Aftermarket “Super Light” Components

Think carefully about your rider profile as outlined above. The more you fit the “shorten product life” profile, the more you must question the use of super light components. The more you fit the “lengthen product life” profile, the more likely it is that lighter components may be suitable for you.

Discuss your needs and your profile very honestly with your retailer. Take these choices seriously and understand that you are responsible for the changes.

A great slogan to discuss with your retailer as you consider changing components: “Strong, Light, Cheap – Pick two.”

Original Equipment Components

GT tests the fatigue life of many of the components that are original equipment on your bike. This means that the designs many original equipment components have met our test criteria and have reasonable fatigue life. It does not mean that the original equipment components will last forever. They will not.

Original Equipment Components

GT tests the fatigue life of many of the components that are original equipment on your bike. This means that the designs many original equipment components have met our test criteria and have reasonable fatigue life. It does not mean that the original equipment components will last forever. They will not.

Stem

Clean and inspect carefully for cracks. Pay particular attention to the underside of the stem. If the stem is of welded construction, examine the edges of each weld. See also the closely related handlebar section below.

Handlebars

Remove from stem. With road bars, you will need to remove the handlebar tape. Remove any handlebar mounted components. Clean and inspect carefully for cracks. Pay particular attention to the area where the handlebar emerges from the stem. This is the area where virtually all handlebars will eventually break. Periodic replacement of all handlebars is strongly recommended. How often they need to be replaced depends upon the many factors outlined above.

Be sure that you do not scratch or score the surface of the handlebars with either the stem or the brake or shifter levers. As noted above, any such damage will reduce the life of the handlebar and could lead to breakage.

If you find that there is a sharp edge or burr on the inside of the stem, right where the handlebars emerge, it must be smoothed out with fine sandpaper (220 grit or finer) before the new handlebars are installed. Such a sharp edge or burr could cause a scratching or scoring of the handlebar. As noted above, any such damage will reduce the life of the handlebar and could lead to breakage.

Seat Post

Remove from seat tube and remove from saddle. Disassemble the head/saddle clamp assembly. Clean and inspect all parts carefully for cracks.

Pay particular attention to the bolt (or bolts) that clamp the saddle in place. If the bolt looks stretched, bent or in any way damaged, replace it. Note that these bolts have been known to be broken due to fatigue when not properly tightened. They must be tightened with a torque wrench.

The threads of the seat post bolts be greased before reassembly.

Be sure the clamp assembly is clamped only to the straight parallel part of the saddle rails.

Seat Post Lubrication

Clean and apply the following to a seat post before inserting into the frame.

Frame material		Seat post lubrication
Seat tube	Seat post	
Alloy	Alloy	Grease
Alloy	Carbon	Carbon gel
Carbon	Alloy	Carbon gel
Carbon	Carbon	Carbon gel

GREASE - A high-quality bicycle bearing grease

CARBON GEL - Is a gel like lubricant formulated for use with carbon fiber components.

Saddle

While the saddle is off the seat post, clean and inspect the rails carefully for cracks. Check the saddle rails to the saddle body; make sure that the rails are firmly attached.

Pedals

Remove both from the crankset. Clean and inspect carefully for cracks. Pay particular attention to the pedal axle. See clipless pedal manufacturer's instructions for information on cleat wear and replacement.

Crankset

Remove both sides from the bottom bracket. Clean and inspect all parts carefully for cracks. Examine both inside and outside surfaces. Pay particular attention to edges, shapes and changes of shape that are a part of your particular crankset design. Also check the area around the pedal mounting holes.

Wheels

Clean the wheels. Inspect the hub flange, where the heads of the spokes are hooked (or otherwise attached) to the hub flange, for cracks. Inspect the rim where the spokes meet the rim. It is not uncommon to see cracks form where the spokes meet the rim.

Brake Track of Wheel Rim

The brake track is the surface of the rim where the brake pads make contact. While not related to fatigue, this surface can be worn out. We urge you to inspect the brake tracks on your rims. They can wear out quite quickly on a mountain bike used in abrasive conditions. Many rims have brake track wear indicators; please ask your retailer to show you this feature.

Some brake pads are very aggressive and speed up wear. If you see a noticeable amount of wear relative to the nearby surface untouched by the brake pads, speak to your retailer about possible replacement. Severely worn brake tracks can lead to a broken wheel.

 **WARNING****Do not ride on a rim that has been worn out!**

If the wear indicator shows that the rim is worn out, there is a danger that the rim could be broken due to tire pressure and/or riding loads.

If the rim breaks while you are riding you could have an accident, with risk of serious injury, paralysis or death.

Bicycle Lifespan

Nothing Lasts Forever, Including Your Bike

When the useful life of your bike or its components is over, continued use is hazardous.

Every GT bicycle frame and the components attached to the frame have a finite, limited useful life. The length of that life will vary with the construction and materials used in the frame and components, the maintenance and care the frame and components receive over their life and the type and amount of use the frame and components are subjected. Use in competitive events, trick riding, ramp riding, jumping, aggressive riding, riding on severe terrain, riding in severe climates, riding with heavy loads, commercial activities and other types of non-standard use can dramatically shorten the life of the frame and components. Any one or a combination of these conditions may result in an unpredictable breakage.

ALL FRAMES AND COMPONENTS SHOULD BE PERIODICALLY CHECKED BY AN AUTHORIZED GT RETAILER for indicators of stress and/or potential breakage, including cracks, deformation, delamination, creaking sounds, corrosion, paint peeling, dents, and any other indicators of potential problems, inappropriate use or abuse. These are important safety checks and very important to help prevent accidents, bodily injury to the rider and shortened product life. (See PART I, Section 5 Service and PART II, Section D. Inspect For Safety)

Useful Life of Lightweight Frames

Lightweight frames and components usually have shorter lives. For example, all aspects of use being identical, a lightweight Super Six, System Six, CAAD7 or CAAD8 frame will have a shorter life than a heavier CAAD3 frame.

In selecting lightweight frames and components you are making a trade-off, favoring the higher performance that comes with light weight over longevity. So, if you choose lightweight, high performance equipment, be sure to inspect it frequently.

Section E. Maintenance

Importance of a Maintenance Routine

WARNING

1. Regular Maintenance is important to your safety and the longevity of your bicycle. Any part of a poorly maintained bike can break or malfunction leading to an accident.

While the materials and workmanship of your bicycle or of individual components may be covered by a warranty for a specified period of time by the manufacturer, this is no guarantee that the product will last the term of the warranty. Product life is often related to the kind of riding you do and to the treatment to which you submit the bicycle. The bicycle's warranty is not meant to suggest that the bicycle cannot be broken or will last forever. It only means that the bicycle is covered subject to the terms of the warranty.

Ask a professional bicycle mechanic to help you develop a complete maintenance program, a program which includes a list of the parts on your bike for YOU to check regularly.

2. All bicycles and bicycle components are subject to wear and stress. Different materials and mechanisms wear or fatigue from stress at different rates and have different life cycles. If a component's life cycle is exceeded, the component can suddenly and catastrophically fail, causing serious injury or death to the rider. Scratches, cracks, fraying and discoloration are signs of stress-caused fatigue and indicate that a part is at the end of its useful life and needs to be replaced.

See also "inspect For Safety" in this manual.

YOU CAN BE SEVERELY INJURED, PARALYZED OR KILLED IN AN ACCIDENT IF YOU IGNORE THIS WARNING.

WARNING

Many bicycle service and repair tasks require special knowledge and tools.

Do not begin any adjustments or service on your bicycle until you have learned from a professional bicycle mechanic how to properly complete them. Improper adjustment or service may result in damage to the bicycle or in an accident which can cause serious injury or death.

Basics of a Good Maintenance Schedule

Some service and maintenance can and should be performed by the owner, and requires no special tools or knowledge beyond what is presented in this manual.

The following are examples of the type of service you should perform yourself. All other service, maintenance and repair should be performed in a properly equipped facility by a qualified bicycle mechanic using the correct tools and procedures specified by the manufacturer.

ALWAYS BEFORE EVERY RIDE:

Perform the "Pre-Ride Checklist" on the back cover of this manual. If your bike fails the Mechanical Safety Check or the other Pre-Ride Checklist items, do not ride it until the problems are corrected.

AFTER THE FIRST FEW RIDES:

Your bike will last longer and work better if you break it in before riding it hard. Control cables and wheel spokes may stretch or "seat" when a new bike is first used and may require readjustment by a professional bike mechanic. See also "Mechanical Safety Check." This section will help you identify some things that need readjustment. But even if everything seems fine to you, it's best to take your bike to a professional bicycle mechanic for a checkup after about 30 days.

Another way to judge when it's time for the first checkup is to bring the bike in after three to five hours of hard off-road use, or about 10 to 15 hours of on-road or more casual off-road use. But if you think something is wrong with the bike, take it to a professional bicycle mechanic before riding it again.

AFTER EVERY LONG OR HARD RIDE:

If the bike has been exposed to water or grit; or at least every 100 miles: Clean the bike and lightly lubricate the chain's rollers with a good quality bicycle chain lubricant. Wipe off excess lubricant with a lint-free cloth. Lubrication is a function of climate. Talk to a bicycle dealer about the best lubricants and the recommended lubrication frequency for your area.

(continued on the next page...)

AFTER EVERY LONG OR HARD RIDE OR AFTER EVERY 10 TO 20 HOURS OF RIDING:

- Squeeze the front brake and rock the bike forward and back. Everything feel solid? If you feel a clunk with each forward or backward movement of the bike, you probably have a loose headset. Have a professional bicycle mechanic check it.
- Lift the front wheel off the ground and swing it from side to side. Feel smooth? If you feel any binding or roughness in the steering, you may have a tight headset. Have a professional bicycle mechanic check it.
- Grab one pedal and rock it toward and away from the center line of the bike; then do the same with the other pedal. Anything feel loose? If so, have a professional bicycle mechanic check it.
- Take a look at the brake pads. Starting to look worn or not hitting the wheel rim squarely? Time to have a professional bicycle mechanic adjust or replace them.
- Carefully check the control cables and cable housings. Any rust? Kinks? Fraying? If so, have a professional bicycle mechanic replace them.
- Squeeze each adjoining pair of spokes on either side of each wheel between your thumb and index finger. Do they all feel about the same? If any feel loose, have a professional bicycle mechanic check the wheel for tension and trueness.
- Check the tires for excess wear, cuts or bruises. Have a professional bicycle mechanic replace them if necessary.

- Check the wheel rims for excess wear, dings, dents, and scratches. Consult your dealer if you see any rim damage.
- Check to make sure that all parts and accessories are still secure, and tighten any which are not.
- Check the frame, particularly in the area around all tube joints; the handlebars; the stem; and the seatpost for any deep scratches, cracks or discoloration. These are signs of stress-caused fatigue and indicate that a part is at the end of its useful life and needs to be replaced. See also "Inspect for Safety" in this manual.

EVERY 25 (HARD OFF-ROAD) TO 50 (ON-ROAD) HOURS OF RIDING:

Take your bike to a professional bicycle mechanic for a complete checkup.

Cleaning Your Bike

Use only water and dish washing liquid.

On suspension forks and shocks, cover adjustment knobs and air filter (if equipped) with a clean plastic bag secured temporarily with a rubber band or masking tape.

Before wiping away dirt, use an ordinary water hose to gently spray off heavy soils and dirt.

CAUTION

DO NOT power wash or spray water under high pressure to clean. Power washing will force contaminants into parts where they will promote corrosion, immediately damage, or result in accelerated wear.

DO NOT use compressed air to dry.

DO NOT use abrasive or harsh chemical cleaner/solvents which can damage the finish or attack and destroy both the outside and internal parts.

When rinsing, avoid directing the spray directly at shock/fork adjusters or bearings.

Importance of Lubrication

After cleaning your bike you should lubricate it. The chain should be lubricated. Consult with a bicycle dealer to choose from among the many types of lubricant products best suited to your climate and riding conditions. The pivot points on your derailleurs should be lubricated. The following parts and components may require lubrication depending on the manufacturer's instructions or recommendation of a professional bike mechanic:

- Drive Chain
- Pivot points - a small drop of oil to each pivot point and wipe off the excess.
- Derailleur cables
- Brake cables
- Brake pivots
- Headset bearings
- Bottom bracket bearings
- Hub bearings
- Freehub
- Seat post to seat tube
- Stem to steering tube

Bicycle Repair / Work Stands

The clamping jaws of a bike stand can generate a crushing force strong enough to seriously damage your frame. See next figure.

CAUTION

Never place your bike in a bike stand by clamping the frame.

Place your bike in a stand by extending the seat post and positioning the stand clamp on the extended seat post. Don't extend beyond the MINIMUM INSERT line marked on the seat post.

Since your carbon seat post can also be damaged by clamping force, adjust the stand clamp for the minimum clamping force needed to secure the bike.

Also, before clamping, clean the post and protect the seat post finish with a rag.

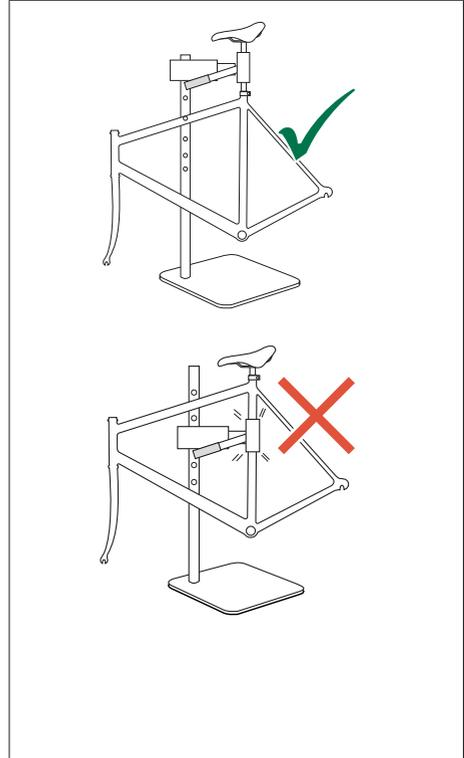

Figure Q

Section F.

Water Bottles

Side impacts to a water bottle or cage can result in damage threaded inserts due to the leverage on a very small area. In a crash, certainly the last thing you should be worried about is saving the threaded inserts in your frame. However, when you are storing or transporting your bike, take steps to prevent situations where a water bottle may be hit or bumped by a strong force that would cause damage. Remove bottle and cage when you are packing your bike for travel.

Periodically check the attachment of the bottle cage; tighten the cage bolts if necessary. Don't ride with a loose bottle cage.

Riding with loose cage bolts can produce a rocking motion or vibration of the attached cage. A loose cage will damage the insert and possibly lead to the inserts to pull out.

It may be possible to repair a loose insert, or install another insert only if the frame is undamaged. Replacement requires the use of a special tool. If you notice damage to the threaded insert, please ask your Authorized GT Dealer for help.



CAUTION

WATER BOTTLES - An impact, crash, or loose bottle cage can result in damage to your frame.

This kind of damage is not covered by the GT Limited Warranty.

Carbon Bikes Temperature Extremes

- Protect your carbon bike from extreme temperatures when storing or transporting it.
- Allow your bike to cool off or warm-up before you ride
- Do not store your bike in places where the temperature will exceed 66.5C° (150°F).

For example, do not leave your bike lying flat in a black pickup truck bed in the desert sun, or, under the glass of a hatchback auto.

Riding Through Water

 **CAUTION**

“Sealed” components (such as HEADSHOK and LEFTY and SUPERMAX, headsets, bottom brackets and hubs) are effective at keeping mud and grit out of your bearings.

However, any bike that is submerged or exposed to large amounts of water will require a complete bearing overhaul to prevent extensive—and expensive—damage.

Shifting Gears While Pedaling

 **CAUTION**

Shifting under extreme pedaling pressure puts a great amount of stress on components. While most components can withstand an occasional “power shift,” continual power shifting will most assuredly damage some part of your drivetrain. Whenever possible, ease up on your pedals when shifting.

Bicycle Car Racks

Bicycle automobile racks are available from many different manufacturers and many different rack designs exist. They are convenient devices to transport your bike. However, any bicycle rack has the potential to seriously damage your bicycle. Damage can occur immediately due to some aspect of an incompatible or poor rack design. Damage can occur after repeated mounting, and dismounting. Damage can also happen while the bike is being transported in the rack. We can't cover all the possible ways in which a rack can cause damage to your bike.

WARNING

READ AND FOLLOW THE RACK MANUFACTURER'S INSTRUCTIONS BEFORE MOUNTING TO YOUR BIKE.

Both carbon and aluminum frames and forks can be damaged (crushed, cracked, or dented) by the clamps and support systems of a bike rack. Both carbon and aluminum can suffer serious abrasion damage by the movement of the bike in the rack during transport. All damage to your bike is very serious, that is why you must take extra care when choosing a bike rack and when actually mounting your bike in the rack.

WHEN MOUNTING YOUR BIKE ON A RACK:

Remove all bags, panniers, water bottles etc. To minimize wind resistance, loading, and avoid chafing damage.

Ask a professional bicycle mechanic for help choosing and using a bike rack.

See the table on the following page for more rack information.

CAUTION

WHEN USING A RACK WITH FORK DROPOUT CLAMPS:

Make sure that both fork dropouts are engaged in the rack before clamping.

Make sure both dropouts are clamped with equal force. If only one dropout is engaged and the bike tips over, the leverage can exert great force that may damage the dropout.

If your bike tips over, have the dropouts examined by a professional bike mechanic.

Types of Car Racks

TYPE OF RACK DESIGN	RECOMMENDATION & CAUTIONS
<p>CLAMPS ON TIRES / WHEELS ONLY</p> <p>This type does not use clamps on any other part of the frame or fork.</p>	<p>Suitable for both carbon and aluminum frames</p> <p>This is the best system design because there is no potential cracking or crushing damage to the frame or fork. Chafing wear is avoided.</p>
<p>FLOATING FORK MOUNT & REAR WHEEL TRAY</p> <p>This design functions exactly as a quick release on your bike. The rear wheel is clamped in a tray. No other clamps are used on any other part of the frame.</p>	<p>Suitable for both carbon and aluminum frames</p> <p>Be sure quick release on rack is properly adjusted and tightly closed.</p> <p>The Thule Echelon with ETC Equalized Twin Cam is suitable as it has an axle floating mechanism, like a standard quick release.</p>
<p>WHEEL CLAMPS & UPRIGHT ARM CLAMP</p> <p>In this design, wheels are clamped in a wheel tray and the bicycle is held upright by and arm clamping the downtube.</p>	<p>Do not use on bikes with carbon fiber downtubes.</p> <p>When clamp is tightened the carbon downtube can be broken. When clamp is looser, chafing can cause structural wear.</p> <p>A loose clamp can allow movement and possible chafing damage. Clean the clamping area to eliminate abrasive particles, pad the clamping area and properly tighten the clamp.</p>

continued next page . . .

TYPE OF RACK DESIGN	RECOMMENDATION & CAUTIONS
<p>NON-FLOATING FORK MOUNT & REAR WHEEL TRAY</p> <p>With this type, a mechanism pulls the two sides of the fork in at the same time, and pulls both sides in the same distance.</p> <p>Example: Thule Peloton.</p>	<p>Not recommended for either carbon or aluminum bikes.</p> <p>If one dropout is slightly thicker than the other dropout, all the clamping force is applied to the thicker dropout. The high force on the one thicker dropout may crack a carbon dropout. The thinner dropout may move in the rack causing wear and abrasion. The fork blade attached to the thicker dropout takes most of the loads caused by 70 mile per hour wind and bumps. The result may be damage to your fork.</p>
<p>HANGER RACK</p> <p>On this type the bicycle hangs on two arms projecting aft from a trunk mounted rack</p>	<p>Not recommended for either carbon or aluminum bikes.</p> <p>Do not use on bikes with carbon fiber tubes.</p> <p>The point loading where the arms contact the underside of the tubes may crack the tubes. Additionally the lower part of the bike is difficult to secure, and it may move, causing chafing and structural wear. Additionally when two bikes are mounted on these racks the contact points between the bikes may be cracked or chafed, causing structural damage.</p>

Using Bicycle Trainers

Potential Damage

CAUTION

Improperly mounting a bike in a trainer, or using one that is not compatible with your particular bike frame can cause serious damage.

This kind of damage is not covered by the GT Limited Warranty.

Ask your dealer for help with trainers, the right one and the correct way to use it.

If you ride a trainer that requires removal of the front wheel and clamps the fork dropouts: Be sure your fork quick release is tight! Relative movement will wear parts, weaken and damage your bike.

If you ride a trainer that holds the bike up by clamping the rear quick release between two cones: Take off the nice, lightweight quick release that came with your bike. Substitute a heavy, classic all steel quick release and clamp it tight! Relative movement will wear parts, weaken and damage your bike. Note that many modern quick releases will not fit the clamping cones in this kind of trainer because their shapes are incompatible.

Be particularly cautious with a carbon frame or fork. Carbon is relatively soft, not abrasion resistant. If there is any relative movement, carbon will wear quickly.

If you ride a trainer a lot, consider using an old bike: Corrosion from sweat will take its toll. Weight is irrelevant. Save wear on your expensive components.

Trainers: Risk To Children

WARNING

Keep children away from bicycles mounted on stationary trainers, even when the bicycle is not in use.

Spinning wheels attract children's attention and present a serious risk to young fingers.

Children have also been known to rotate cranks by hand on bicycles left unattended on stationary trainers, putting themselves at risk of serious injury.

Applying Frame Protection

Some areas of your bicycle require protection from abrasion. If protection is not in place, damage can result. Please consult with your Authorized GT Dealer about the replacement location and position of these various frame protections.

NOTE: Damage to your bike resulting cable rub is not covered under your warranty. Make sure the protections indicated below are in place whenever you ride your bike. Ask your Authorized GT Dealer for help.

Housing and Cable Guides

Normal line and cable movement against the frame can wear away painted finishes and decals.

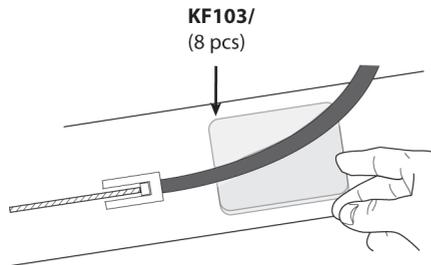

Figure 23.

To apply the guard material:

1. Clean the frame with a mild detergent and wipe dry with a clean towel. Do not use solvents or harsh chemicals to clean the frame. **OPTIONAL:** Trim the adhesive guard material to the shape required.
2. Remove the backing and position the guard under the cable/ line.

3. Rub the guard firmly against the frame with your fingers to fix it in place.
4. Periodically, recheck the guards and other areas of the frame as you continue to ride. Replace the guards if they wear out.

Also, adhesive frame guards are not a fix for incorrectly installed or routed cables or lines. If you find that applied guards are wearing out very quickly, consult with your Authorized GT Dealer about the routing on your bike.



Figure 25.

This photo shows a typical use of guard material at a contact point.

- Headtube area
- Seattube
- Pivots areas
- Anywhere a control cable or housing may contact the frame.

CAUTION

Over time, cable rubbing can wear into the frame itself causing very serious frame damage.

Check over your bike after your first few rides. Apply the guard material where rubbing is found. When applied correctly and renewed when worn, the guard material is good protection for your bike.

Right Chainstay Plate

On mountain or road bikes, the chainstay plate (1) is located on the right chainstay (2) just behind the chainrings (3). This plate protects the carbon (composite) chainstay from damage in the event the chain is dropped from the chainring.

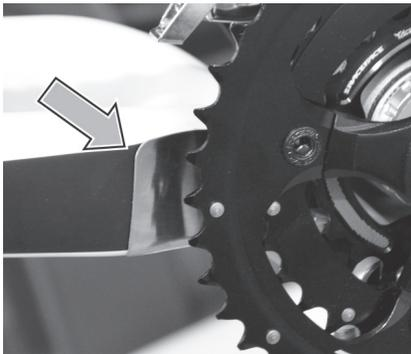

Figure 25.

Downtube Protector

On mountain bikes, placement on the down tube protector (1) on the downtube (2) reduces the potential for damage caused by debris thrown by the wheel. For some bikes, the protector is a fitted adhesive backed material. Some bike models may have light weight plastic formed guards.

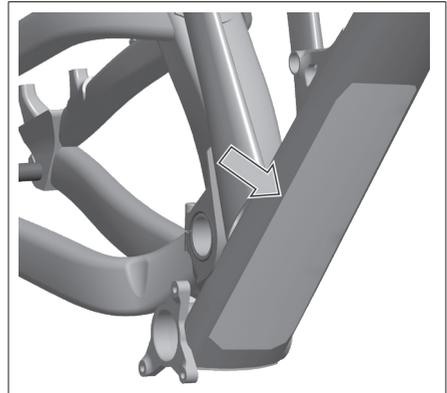

Figure 26.

Chainstay Protector

On mountain or road bikes, the chainstay protector is a clear, adhesive film applied to the upper surface of the right chainstay. This protector can prevent damage to the chainstay caused by the chain.

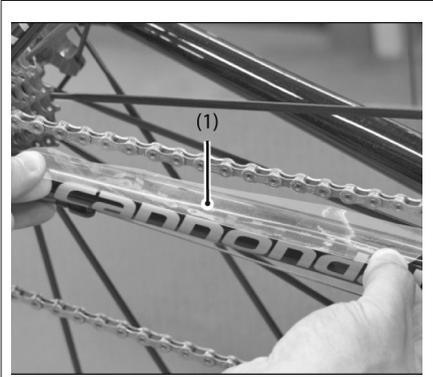

Figure 26.

On mountain bikes, a wrap-around or snap on type protector (1) can be installed as additional protection.

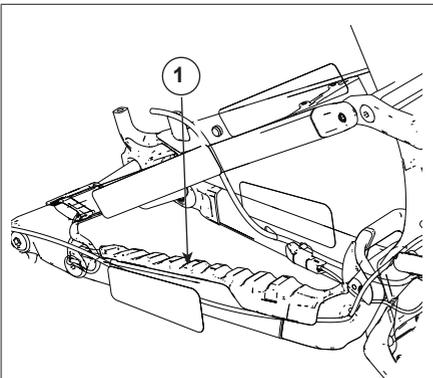

Figure 26.

PART 3

Assembling Your Bike

STEP 1. Introduction

These instructions cover many different types of bicycles and components. As a result, some sections of these instructions will apply to your particular bike, and some will not. For example, bikes generally have one of three different kinds of braking systems - V-Brakes, caliper brakes or disc brakes - so you will need to identify which type your bike has and follow the instructions for that type of braking system.

We know you are eager to finish the assembly of your bike quickly and get out riding, but when a bike is incorrectly assembled it can be dangerous, so please take the time to carefully read and follow these instructions and use the illustrations to double check everything has been done correctly. Help is available from a variety of different sources, described in the next section.

WARNING

Failure to assemble and adjust your bike correctly could lead to an accident, with risk of serious injury, paralysis or death.

To minimize this risk we encourage you to consider bringing your bike to a professional mechanic at a local bicycle retailer. Even if you choose to assemble the bike yourself, a professional mechanic can double check the assembly and confirm your bike is ready for many miles of trouble-free riding.

STEP 2. Consulting Resources

Before you start and as you work, please watch the assembly videos at: www.cannondale.com under SUPPORT, Help Center and then Owner's Manuals and Assembly.
And at www.gtbicycles.com under Support, then ASSEMBLY

There are excellent bicycle mechanical videos from bicycle tool industry leader Park Tool at <https://www.parktool.com/blog/repair-help>

We urge you to reach out to your local retailer or Customer Service at 1-800 BIKEUSA with any questions regarding final assembly or use of your bike.

 **WARNING**

These instructions are for assembly of your bike only. You must also read the entire Owner's Manual, Owner's Manual Supplements, and component manufacturers instructions for important information and warnings about the operation of your bike before riding it.

Copies of your Owner's Manual and any Owner's Manual Supplements (Supplements often provide important warnings, instructions and maintenance information for specific bike designs or families of designs) are also available under the SUPPORT page of www.cannondale.com or at www.gt bicycles.com

Additional information about some of the components of your bike may be provided by the manufacturer of that component. You can identify the make and model of a component and can access instructions on that manufacturer's website. For example:

Shimano: <https://si.shimano.com/#/> SRAM: <https://www.sram.com/en/service>

STEP 3. Tools And Good Working Area

- Metric Allen wrench set (e.g., bicycle multi-tool with 3, 4, 5, 6, 8 and 10mm Allen wrenches)
- For bikes with 6 bolt disc brakes a T25 Torx wrench and bit.
- Torque wrench that reads in Nm (Newton Meters) and can use 4, 5, and 6mm Allen bits and T25 Torx bit.
- o A torque wrench is special kind of wrench that allows you to turn a bolt to exactly the right level of tightness. A bolt that is too loose won't do it's job, and a bolt that is overtightened can break – either right away or over time and use. If you are going to assemble your bike yourself, you need a torque wrench.
- Center lock disc brakes will require tools like the Park FR-5.2 or Park BBT-69.2
- Large adjustable wrench
- Phillips screwdriver
- Bicycle cable cutters
- Pliers

- Pedal wrench, or long 15mm open-end wrench to install pedals and axle nuts
- o A bicycle pedal wrench is a special wrench to install and remove pedals, or tighten them. It is long, to provide enough leverage to tighten and remove pedals, and has special jaw grips that are narrow enough to fit the wrench flats on bicycle pedal axles.
- 13, 14 mm open-end wrench or adjustable wrench for the stem and seatpost on some models of kid's bikes
- Grease- a small tube is plenty
- Isopropyl alcohol
- A bike work stand is great, but not essential. The assembly videos show how to use the bike carton as a useful temporary stand.

Exactly which of these tools you will need will depend upon the model of bike you are assembling. Details regarding particular tools are covered in the particular sections of these assembly instructions.

Working in a garage or workshop with good lighting is ideal. If you must work inside your house, we suggest you protect surfaces from grease using cardboard or old towels.

A helper is very helpful! For many steps having a person to hold the bike in position makes the job easier.

STEP 4. Getting Your Bike Ready For Assembly

- Inspect the box for damage. If you see damage, stop. Contact the retailer you purchased the bike from.
- Open the top of the carton. Use a screwdriver, not your fingers. Remove all the sharp staples with pliers.
- Lift the bike out of the carton. Find and remove the small parts box and any other loose parts from the carton.
- Open the small parts box and lay out the contents.

- Place the bike on top of the carton on its side. Remove all packaging materials from the bike. Use diagonal cutting pliers or stout scissors to cut the zip ties. The front wheel is nested over the left crank arm. Carefully work the wheel forward until the front wheel spokes are free of the crank arm. Set the front wheel aside.
- If you don't have a work stand, place the bike back in the carton vertically, with the rear wheel down on the bottom of the carton and the fork hanging over the end of the carton. As you do so be sure that the fork and stem faces forward. Set in the carton this way, the bike is held upright in a convenient place for much of the assembly work.

STEP 5. Installing the Seatpost And Saddle

- If the seatpost/saddle assembly has been removed for shipping, install it in seat tube. You may need to slightly loosen the clamp bolt or quick-release clamping mechanism. Aluminum frames: Grease inside the seat tube and on the seat post. Grease prevents corrosion which can cause a seatpost to seize in a frame. Carbon frames: Use carbon paste inside the seat tube and on the seat post. Carbon paste improves clamping of the seat post without excess torque that could cause damage. If the seat post does not smoothly fit into the frame, do not force it. Contact your local bike retailer or call 1-800 BIKEUSA.
- There are three major types of seat post attachment: Clamp Bolt, Hidden Clamp Bolt, and Quick Release

Clamp Bolt

1. This type requires an allen wrench to tighten or loosen a bolt that clamps the seat post in the seat tube.

Hidden Clamp Bolt

1. This is very similar to the clamp bolt style, but the bolt will be recessed, hidden from sight for a cleaner, sleeker look. For example, the hidden clamp bolt may be at the underside of the junction of the seat tube and the top tube. Use care to identify the correct allen wrench size. Note the angle of the bolt and carefully keep the allen wrench aligned.

Clamp Bolt Seat Clamp

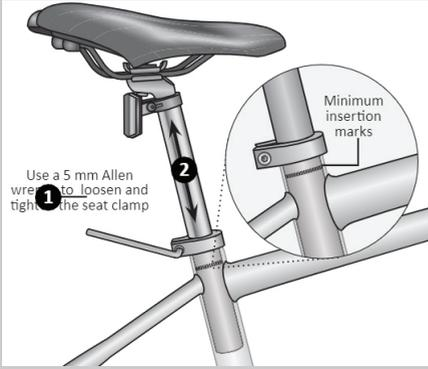

Hidden Clamp Bolt



Quick-Release Seat Clamp

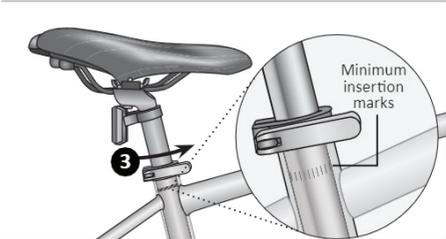
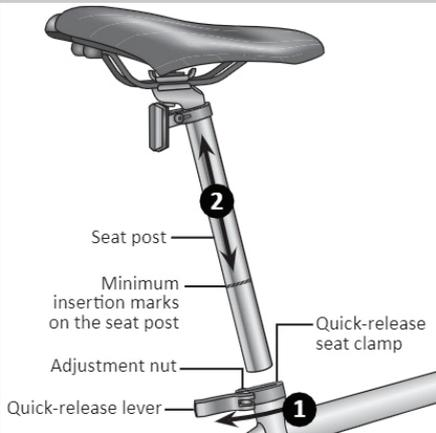

Quick Release Seat Post

This type allows a properly adjusted quick release to adjust and clamp the seat without tools. Proper initial adjustment of the quick release type may be either with a hand adjustable nut, or a nut that is adjusted with an allen wrench.

1. Hold the lever end of the quick release open and stationary.
2. Turn the adjusting nut clockwise to tighten it. Keep turning until you see or feel it contact the frame.
3. Try closing the lever. Your goal is to tighten the adjusting nut enough so that the lever can be closed but requires significant force to close. You want it to be hard to close, you want to see the lever temporarily leave a mark on your hand. If it is not hard to close, open and hold the lever and further tighten the adjusting nut, try again to close. If it is not possible to close or very, very hard to close, open and hold the lever and slightly loosen the adjusting nut, try again. Towards the end of the adjustment process, quite small changes, fractions of a turn, of the adjusting nut are necessary.
4. The lever must be hard to close, the lever must leave a mark on your hand, and the final position of the lever more than 90 degrees (relative to the bolt) closed.

For all styles, initially tighten the clamp bolt or quick-release clamping mechanism. A good starting point is to have the saddle about level with your hip. After test riding you will adjust again to tune fit to your body size and leg length.

Using a torque wrench and the correct size bit, tighten clamp bolts and hidden clamp bolts to the torque value marked. If no torque marking is present, tighten to 7Nm.

WARNING

All seat posts have a minimum insertion line. The seat post must be inserted far enough into the bike seat tube to cover this line.

Do not ride without properly adjusting the seat post height and securely tightening the seat post clamp or quick-release clamping mechanism.

Failure to observe the minimum insertion line or properly tightening the clamping mechanism could result in seat post system failure, which could lead to an accident, with risk of serious injury, paralysis or death.

STEP 6. Installing the Handlebar And Stem

Your bike will normally be shipped to you with the handlebar assembly (handlebars, brake and shift levers with all cables attached) packed beside the bike. After you removed all packaging, this assembly will be loose.

Two packaging methods are used: (A) stem is attached to steering tube. With this method you will install the handlebars using the face plate on the stem. (B) Stem is attached to the handlebars and a cardboard spacer is on the steering tube. With this method you will install the handlebar/stem assembly.

On a bike with disc brakes, do not pull the brake levers before the front wheel with the brake rotor is installed. Doing so may push the brake pads out of position.

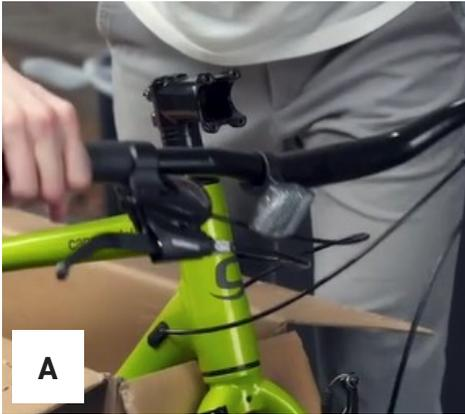

Method A: Stem is attached to steering tube:

Confirm that the fork and handlebar stem face forward.

Remove the stem faceplate. Remove the 2 or 4 bolts holding the faceplate on the stem using a 4mm or 5mm hex wrench. Set the faceplate and bolts within easy reach.

Rotate the handlebar so cables/housings run properly. The rear shifter should be on the rider's right hand side. Holding bars against the front end of stem, secure the faceplate over the bars. Install one bolt first to hold the assembly in place. Then install all faceplate bolts through the faceplate and into the stem. Most handlebars have markings that make it easier to center the handlebars. Just snug the bolts enough to hold the assembly in place.

Check for proper cable/housing orientation. Consult photos and our assembly videos.

The right brake lever controls the rear brake. The rear brake housing will run from the right brake lever around the left side of the head-tube and into the cable stop.

The left brake lever controls the front brake. The front brake housing will run from the left brake lever forward and down towards the front brakes.

The two derailleur housings will run along side the headtube and into the cable housing stops near the front of the frame. Be sure that the housing ends are inside the cable housing stops. See below:

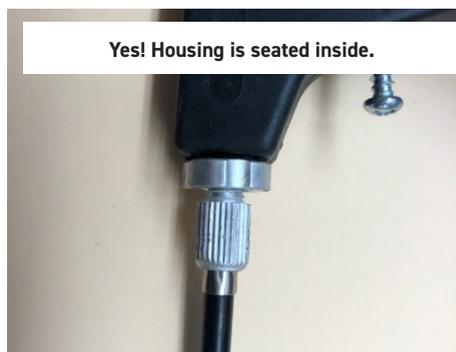

Set up handlebar and brake lever angle:

With the faceplate bolts still just snug (if necessary, loosen slightly to allow adjustment):

- Center handlebar in the stem. Most handlebars have aiming marks.
- Rotate to set brake lever angle.
- On a mountain bike or flat bar road bike (A), most riders like the brake levers at a 45-degree angle with the ground.
- On a road bike with drop bars (B), most riders like the handlebar set where the flat area at the top or the bottom of the handlebar is parallel to the ground.

Final tightening of stem faceplate bolts:

1. When you like the handlebar position, tighten the faceplate bolts (2 or 4) as evenly as possible; alternating in a crisscross pattern so that the gap between the stem and faceplate is equal – top/bottom, left/right.
2. Using a torque wrench and the correct size bit, tighten all faceplate bolts to the torque value marked on the stem faceplate. If no torque marking is present, tighten to 7Nm.



Stem to fork steering tube set up:

Be sure that any fork protection spacer has been removed from the dropouts, the bottom parts of the fork.

Take the bike out of the carton and place the fork dropouts on the floor. Keep the fork aiming forward. Pivot the stem so that it faces directly forward.

Find the stem clamping bolts on the back of the stem. These are the bolts that hold the stem/handlebar assembly in place on the steering tube of the fork. Tighten these bolts using a torque wrench to the torque value marked on the stem. If no torque marking is present, tighten to 7Nm.



Method B, Stem is attached to the handlebars:

Remove the plastic fork protector from the bottom of the fork.

Set the bike on the floor. The rear wheel is already installed. As you set the fork on the floor be sure that the fork is aimed forward. This will make it possible for the bike to balance on the floor. Confirm that the fork is oriented forward. One way to check this is that the brake caliper will be on the left side of the bike.

Now that the weight of the bike is pushing down on the fork remove the top cap. This is done by un-threading the top cap bolt with a 5 mm allen wrench. Once loose, remove the top cap and bolt as an assembly and set it nearby.

Remove the cardboard tube from the steering tube of the fork. You can discard, recycle, it is just a spacer for packaging.

There will be one or more round metal spacers on the steering tube. Leave them in place.

Now take the complete stem and handlebar assembly and slide the stem over the steering tube. Be sure that the handlebar assembly is properly oriented. A good way to check this is to be sure that:

- The shifters are facing up, towards you.
- The brake lever on the right controls the rear brake. The rear brake is already connected to the right hand brake lever, so you can squeeze the lever and see that you have the right hand brake lever on the correct side of the bike.
- The left hand brake lever will be connected to the front brake, but is not at this point.

Once you are sure that the orientation is correct, place the top cap and bolt on top of the stem. Thread the bolt into the threaded fitting inside the steering tube. Snug this bolt with the 5 mm allen wrench. Rock the bike forward and back a bit and snug this bolt to eliminate play. You are setting the bearing pre-load on the headset, the bearings on which the fork pivots. You want to tighten enough to eliminate noticeable play but want the fork to turn freely without a lot of resistance. No torque spec here, it's a matter of feel. Not super tight, but more than finger tight.

Now move the handlebar and stem assembly so that the stem faces directly forward. You can sight where the front wheel will be in the fork. Once centered, use a 5mm allen wrench to tighten the two stem clamp bolts to the spec marked on the stem or 7 Nm. You are now clamping the handlebar and stem assembly to the steering tube and fork so that you can control the bike.

After the wheel is installed and you are doing a final pre-ride check, if you find that the handlebar and stem assembly is not quite centered, you can loosen the two stem clamp bolts, center the assembly and then torque the stem clamp bolts to the spec marked on the stem or 7 Nm.

STEP 7. Installing Brake Disc to Wheel Hub

If your bike already has the disc brake rotor installed on the front wheel, skip down to step 8.

Six bolt type:

Find the disc brake rotor, mounting bolts and remove all packaging materials. Look at the front wheel and note that one side of the hub has six threaded holes.

Set the disc brake rotor over these holes. Carefully note and follow directional markings on the disc brake rotor. Markings will face out. Find the six Torx T25 bolts and place them through the dog bone shaped locking washers, positioned with the sharp tabs up. Place bolts through the holes in the disc brake rotor and thread each one into the threaded holes in the hub. Each bolt will have some thread retaining compound on the threads, often blue color. This compound makes it more difficult to turn the bolt. So, once you have started all six bolts by hand you will need a T25 Torx wrench to turn the bolts. Tighten all six bolt snugly.

After all six bolts are snug, fit the Torx T25 bit to a torque wrench and tighten each bolt to the torque specification marked on the rotor. Be sure the tool is properly engaged as this tool interface is rather shallow. It is important to torque these bolts in a crisscross or star pattern. With the wheel stationary in front of you torque the (1) 12 o'clock bolt, then (2) the six o'clock bolt, then (3) the 10 o'clock bolt, then (4) the 4 o'clock bolt, then (5) the 8 o'clock bolt and finally (6) the 2 o'clock bolt.

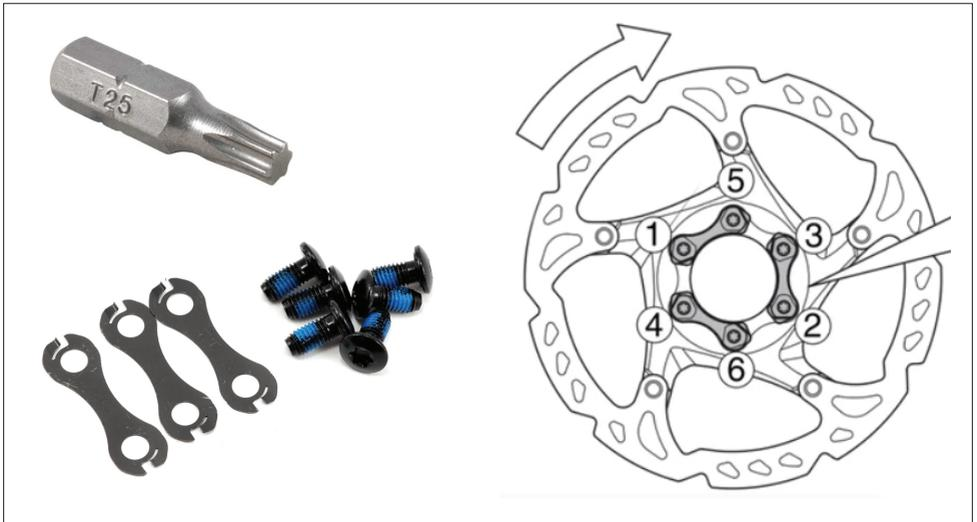

Center Lock or Spline type:

Find the disc brake rotor, retaining lock ring, and remove all packaging materials. Look at the rotor and note an internal splined interface. Look at the front wheel and note that one side of the hub has an external splined interface.

Set the disc brake rotor over these splines. Carefully note and follow directional markings on the disc brake rotor. Markings will face out. Find the retaining lock ring and by hand carefully thread it onto the threads in the hub.

Next you will need the correct tool to tighten this retaining lock ring. There are two common designs: (a) internally driven lock rings use a 12 spline tool also used for cassette lockrings, e.g. the Park FR-5.2 (b) externally driven lock rings use a 16 notch tool also used for bottom bracket installation, e.g. the Park BBT-69.2 or BBT-9. Carefully check the fit between the tool and the lock ring. Once sure you have the correct tool correctly fitted to the lock ring, use a torque wrench to tighten this retaining lock ring to the specified torque. If you use a large adjustable wrench, make these are very tight. You will feel the retaining lock ring click or bump over a series of locking features as you do so. This is normal and indicates you are engaging these locking features.

All types:

Be sure there is no grease or oil, even from your hands, on the rotor. Clean the braking surfaces of the rotor with isopropyl alcohol.

8. Install Front Wheel

Identify your wheel attachment system and follow the instructions for that system.

There are six common systems:

(A) - Quick Release

(B) - Tool-Driven Quick-Release

(C) - Thru-Axles

(D) - Thru Axles/ Pinch Bolts

(E) - Lefty

(F) - Nuted/Bolt-On

(A) - Quick Release

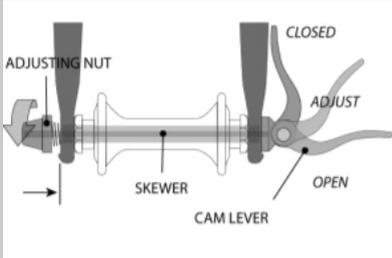

(B) -Tool-Driven Quick Release

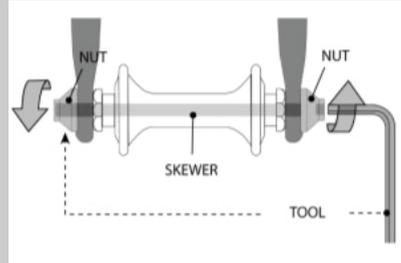

(C) - Thru-Axles



(D) - Thru-Axles / Pinch Bolts



(E) - Lefty



(F) - Nuted/Bolt-On

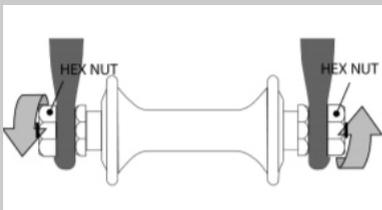

(A) Quick Release Type

First properly install the quick release assembly into the hub. Pick up the quick release assembly and note the sequence and orientation of parts: adjusting nut, conical spring, skewer, a second conical spring and finally the quick release lever assembly.



- Remove the adjusting nut and the first conical spring.
- Pick up the front wheel. Examine the sidewall of the tire to see if the tread design is directional. If it is directional, you will see a forward rotation arrow.

- Insert the skewer through the hollow axle in the center of the hub. On a bike with disc brakes position quick release lever assembly on the side opposite the brake disc.
- Reinstall the conical spring over the threaded end of the skewer, small end first.
- If quick release has a cam follower, a semicircular separate part, be sure it is properly aligned.

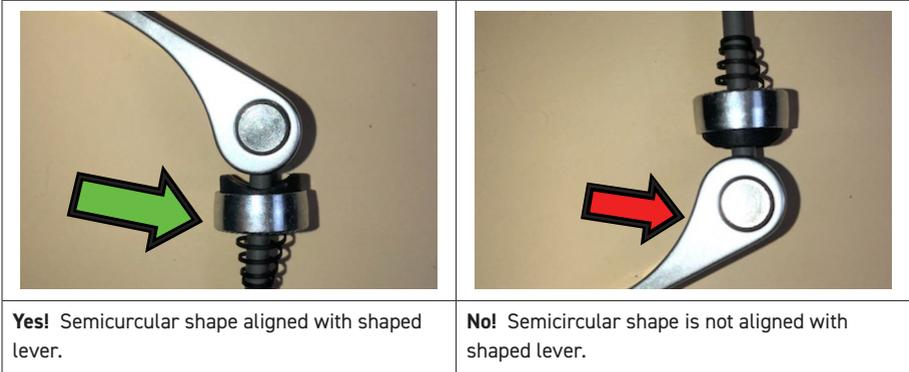

- Reinstall the adjusting nut, threading it onto the threaded end of the skewer. Turn the adjusting nut only a few turns at this stage. The critical final quick release adjustment will be made after the wheel is installed in the fork.

If your bike has disc brakes

Remove the disc brake shipping spacer from the caliper. This is a brightly colored plastic spacer used with hydraulic disc brakes. After the spacer is removed, before the wheel is installed, do not pull the front brake lever. If you accidentally pull the front brake lever the brake pads will need to be pushed outwards to allow the wheel to be installed.

**Rim brakes, two types-**

Before installing the front wheel, if the front brake is V Brake (aka Linear pull) or Caliper it may need to be released to allow the tire to fit between the brake pads. See section 8.

If your bike has V brake type rim brakes:

Temporarily disconnect the curved brake cable guide from the bracket that holds it. Note how the smaller diameter lower end of this curved cable guide fits into the bracket. After you disconnect, the brake arms and pads will spring outward, creating more space for the wheel.

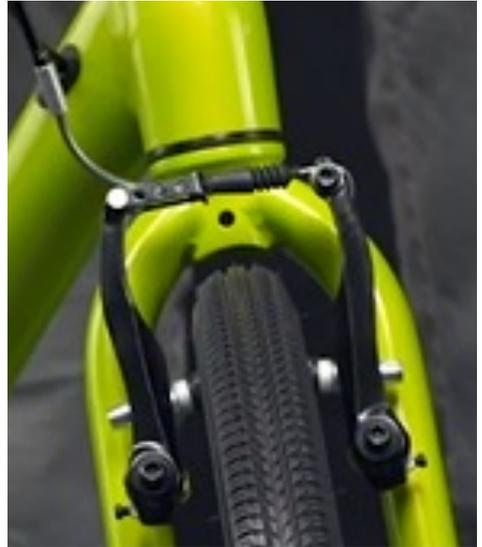

If your bike has caliper type rim brakes:

Locate the front brake quick release lever on the brake caliper. Move this lever up. You will see the caliper arms and brake pads spring outward, creating more space for the wheel.



Placing wheel in fork:**DISC:**

Lift the fork and position the front wheel under the fork. First align the brake rotor (the shiny disc attached to the wheel) with the brake caliper (the part mounted to the fork). As you lower the fork, carefully position the wheel so that the brake rotor fits into the slot in the brake caliper. Next lower the fork further and align the hub axle ends with the fork dropouts.

V BRAKE and CALIPER:

Lift the fork and position the front wheel under the fork. First align the wheel so that the tire fits between the brakes. Next lower the fork further and align the hub axle ends with the fork dropouts.

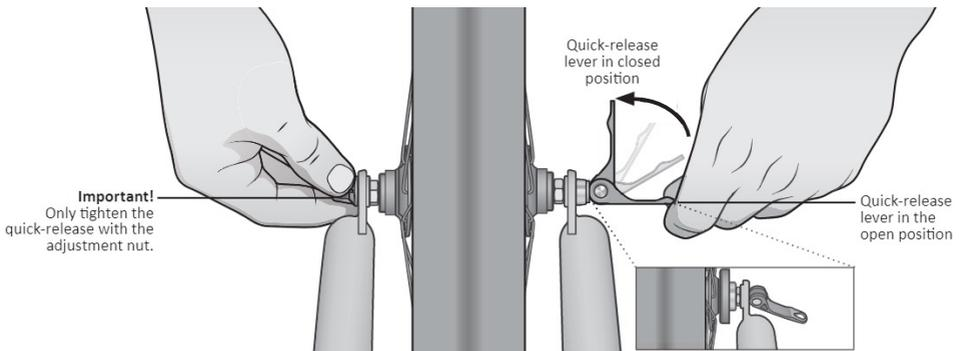

Be sure that the axle at both ends of the hub is fully engaged with the dropouts on the fork. Push down on the front of the bike and hold the bike upright. When fully and properly engaged you will see that the wheel is centered in the fork, that there is the same amount of space between the tire and the inside of the fork on both sides.

Next hold the lever end of the quick release open and stationary. Position the quick release lever so that it is behind the fork and when closed the lever does not make contact with any part of the fork.

Turn the adjusting nut clockwise to tighten it. Keep turning until you feel it contact the face of the dropout.

Next try closing the lever. Your goal is to tighten the adjusting nut enough so that the lever can be closed but requires significant force to close. You want it to be hard to close, you want to see the lever leave a mark on your hand. If not hard to close, continue to hold the lever and further tighten the adjusting nut, try again to close. If not possible to close or very, very hard to close, hold the lever and slightly loosen the adjusting nut, try again. Towards the end of the adjustment process, quite small changes, like $\frac{1}{2}$ turn, of the adjusting nut are necessary.



Your goal is to tighten the adjusting nut enough so that the lever can be closed but requires significant force to close. The lever must be hard to close, the lever must leave a temporary mark on your hand, and the final position of the lever must be more than 90 degrees closed.

WARNING

Because properly installing the front wheel is critical to your safety, please also read the wheel installation instructions contained in the Owner's Manuals that came with your bike. See video instructions on our SUPPORT page at www.gt bicycles.com.

Exact URL: <https://support.gt bicycles.com/hc/en-us/sections/1500000666522-Assembly>

**WARNING**

Securely clamping the wheel with a cam action retention device takes considerable force.

If you can fully close the cam lever without wrapping your fingers around the fork blade for leverage and the lever does not leave a clear imprint in the palm of your hand, the tension is insufficient. Open the lever; turn the tension adjusting nut clockwise a quarter turn; then try again.

(B) Tool driven Quick Release

5mm hex security Quick Release

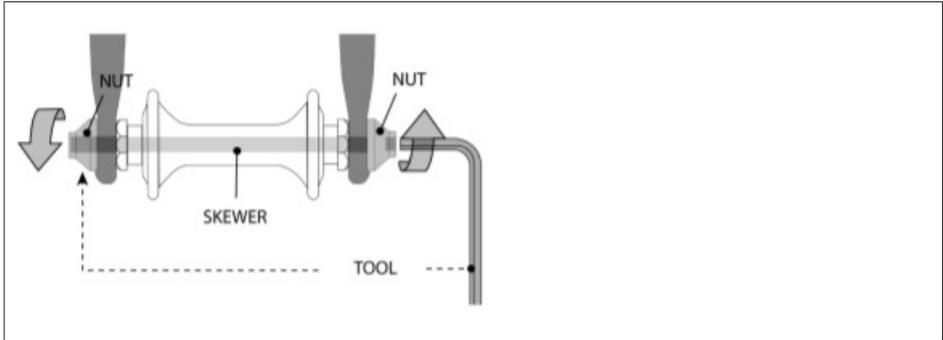

This is a design that uses standard Quick Release assembly parts but is clamped by a special nut that is tightened by a 5mm allen wrench. This system was developed for urban bikes to reduce the risk of theft of the front wheel. By requiring a tool to remove the front wheel, it is slower for the thief and he may pick another target.

First properly install the 5mm quick release assembly into the hub. Pick up the 5mm quick release assembly and note the sequence and orientation of parts: adjusting nut, conical spring, skewer, a second conical spring and finally the special nut that is turned by a 5mm allen wrench.

- Remove the adjusting nut and the first conical spring.
- Pick up the front wheel. Examine the sidewall of the tire to see if the tread design is directional. If it is directional, you will see a forward rotation arrow.
- Insert the skewer through the hollow axle in the center of the hub. On a bike with disc brakes position the 5mm nut on the side opposite the brake disc.
- Reinstall the conical spring over the threaded end of the skewer, small end first.
- Reinstall the adjusting nut, threading it onto the threaded end of the skewer. Turn the adjusting nut only a few turns at this stage. Tightening the 5mm nut will be done after the wheel is installed in the fork.

If your bike has Rim brakes- Before installing the front wheel, if the front brake is V Brake (aka Linear pull) or Caliper it may need to be released to allow the tire to fit between the brake pads. See Section 8.

If your bike has Disc brakes- Remove the disc brake shipping spacer from the caliper. This is a brightly colored plastic spacer used with hydraulic disc brakes. After the spacer is removed, before the wheel is installed, do not squeeze the front brake lever. If you do squeeze the front brake lever the brake pads will need to be pushed outwards.

If your bike has V brakes: Temporarily disconnect the curved brake cable guide from the bracket that holds it. Note how the smaller diameter lower end of this curved cable guide fits into the bracket. After you disconnect, the brake arms and pads will spring outward, creating more space for the wheel.

Placing wheel in fork:

If your bike has Disc brakes: Lift the fork and position the front wheel under the fork. First align the brake rotor (the shiny disc attached to the wheel) with the brake caliper (the part mounted to the fork). As you lower the fork, carefully position the wheel so that the brake rotor fits into the slot in the brake caliper. Next lower the fork further and align the hub axle ends with the fork dropouts.

If your bike has V Brakes or Caliper brakes: Lift the fork and position the front wheel under the fork. First align the wheel so that the tire fits between the brakes. Next lower the fork further and align the hub axle ends with the fork dropouts.





Be sure that the axle at both ends of the hub is fully engaged with the dropouts on the fork. Push down on the front of the bike and hold the bike upright. When fully and properly engaged you will see that the wheel is centered in the fork, that there is the same amount of space between the tire and the inside of the fork on both sides.

Next hold the adjusting nut stationary. Use a 5MM allen wrench to turn the 5mm nut clockwise to tighten it. The skewer should be very tight. When properly tightened, the Allen wrench will leave an imprint in your hand.

Finally use a torque wrench to torque this 5mm nut to 8 Nm. This is quite tight.

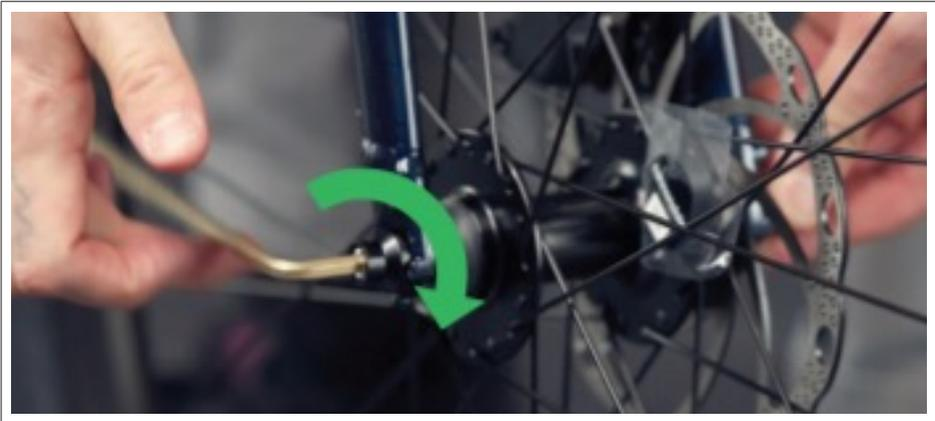

WARNING

Because properly installing the front wheel is critical to your safety, please also read the wheel installation instructions contained in the Owner's Manuals that came with your bike. See video instructions on our SUPPORT page at www.gt bicycles.com.

Exact URL: <https://support.gt bicycles.com/hc/en-us/sections/1500000666522-Assembly>



(C) Through Axle Type

For shipping, the through axle will be threaded into the fork dropouts or be in the small parts box. Pick up the through axle and note the orientation of the two ends. One end is threaded, it will thread into a female threaded hole in the right dropout. One end is made to be turned with an allen wrench or has a built-in lever to turn it.



Remove the disc brake shipping spacer from the caliper. This is a brightly colored plastic spacer used with hydraulic disc brakes. After the spacer is removed, before the wheel is installed, do not pull the front brake lever. If you accidentally pull the front brake lever the brake pads will need to be pushed outwards to allow the wheel to be installed.

Lift the fork and position the front wheel under the fork. First align the brake rotor (the shiny disc attached to the wheel) with the brake caliper (the part mounted to the fork). As you lower the fork, carefully position the wheel so that the brake rotor fits into the slot in the brake caliper. Next lower the fork further and align the hub axle ends with the fork dropouts.

Be sure that the axle at both ends of the hub is fully engaged with the dropouts on the fork. Push down on the front of the bike and hold the bike upright. When fully and properly engaged you will see that the wheel is centered in the fork, that there is the same amount of space between the tire and the inside of the fork on both sides.

Push the through axle through the hole in the left dropout and the hole in the axle. When you feel resistance stop pushing. Begin threading, with an allen wrench or the built-in lever. You will see and feel the through axle threading into the threads in the right dropout until it stops turning. Torque to torque value marked on the through axle. This part must be very tight.



WARNING

Because properly installing the front wheel is critical to your safety, please also read the wheel installation instructions contained in the Owner's Manuals that came with your bike. See video instructions on our SUPPORT page at www.gtbicycles.com.

Exact URL: <https://support.gtbicycles.com/hc/en-us/sections/1500000666522-Assembly>



(D) Through Axle/Pinch bolt Type

This type uses a threaded through axle as described in (E) that is then also clamped in place by pinch bolts in the fork dropouts. This type is used on heavy duty suspension forks. For your safety and to optimize the performance of your suspension fork and bike, please find and read the separate suspension fork owner's manual included with your bike or visit the manufacturers site.

Fox forks www.ridefox.com go to BIKE, then TECH HELP

Rockshox forks www.sram.com go to Rockshox, then SERVICE/SUPPORT

SR Suntour forks www.srsuntour.us go to PRODUCT SUPPORT



For shipping, the through axle will be threaded into the fork dropouts or be in the small parts box. Pick up the through axle and note the orientation of the two ends. One end is threaded, will thread into a female threaded hole in the right dropout. One end is made to be turned with an allen wrench or has a built-in lever to turn it.

Lift the fork and position the front wheel under the fork. First align the brake rotor (the shiny disc attached to the wheel) with the brake caliper (the part mounted to the fork). As you lower the fork, carefully position the wheel so that the brake rotor fits into the slot in the brake caliper. Next lower the fork further and align the hub axle ends with the fork dropouts.

Be sure that the axle at both ends of the hub is fully engaged with the dropouts on the fork. Push down on the front of the bike and hold the bike upright. When fully and properly engaged you will see that the wheel is centered in the fork, that there is the same amount of space between the tire and the inside of the fork on both sides.

Push the through axle through the hole in the left dropout and the hole in the axle. When you feel resistance stop pushing. Begin threading, with an allen wrench or the built-in lever. You will see and feel the through axle threading into the threads in the right dropout until it stops turning.

There will be one or two pinch bolts in each of the dropouts. Tighten these bolts.

Torque Pinch bolts and through axle to torque values marked on the fork.

 **WARNING**

Because properly installing the front wheel is critical to your safety, please also read the wheel installation instructions contained in the Owner's Manuals that came with your bike. See video instructions on our SUPPORT page at www.gtbicycles.com.

Exact URL: <https://support.gtbicycles.com/hc/en-us/sections/1500000666522-Assembly>



(F) Nuted or Bolt-On Type

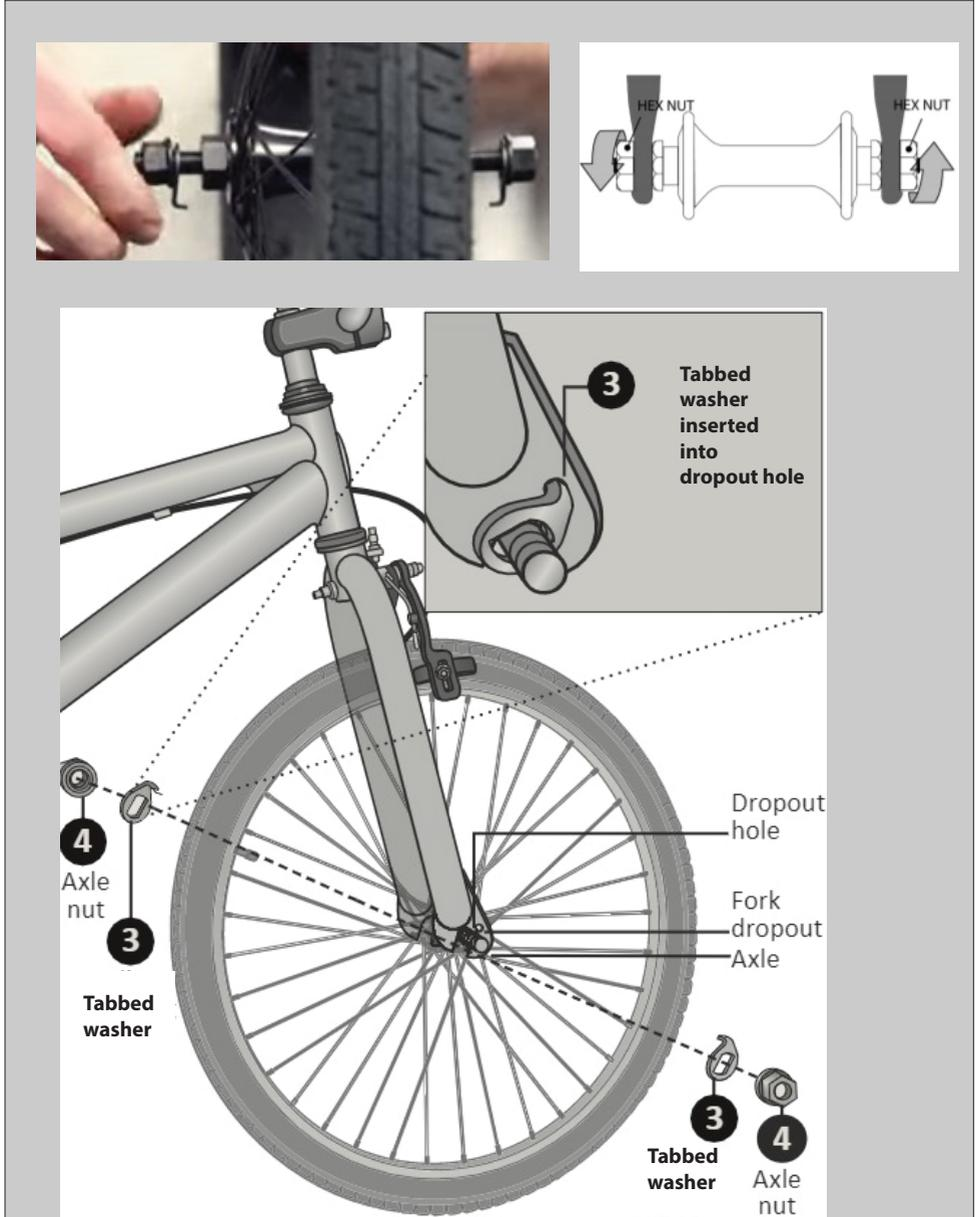

Pick up the front wheel and look at the axle. The axle nuts will be threaded onto the hub axle. Inside each of the axle nuts is a tabbed washer. To ease installation, turn both nuts counterclockwise and push the tabbed washers out to create some space on the axle so that the axle fits onto the dropouts.

Be sure that the axle at both ends of the hub is fully engaged with the dropouts on the fork. Push down on the front of the bike and hold the bike upright. When fully and properly engaged you will see that the wheel is centered in the fork, that there is the same amount of space between the tire and the inside of the fork on both sides.

Carefully fit the tab of each tabbed washer into the mating holes in the dropout above the axle. Then hand tighten both axle nuts, being sure that each of the tabbed washers stay in their respective holes.

Use a 15mm or large adjustable wrench to tighten both axle nuts.

Turn clockwise, "Righty-Tighty".

Make the nuts very tight.



WARNING

Because properly installing the front wheel is critical to your safety, please also read the wheel installation instructions contained in the Owner's Manuals that came with your bike. See video instructions on our SUPPORT page at www.gt bicycles.com.

Exact URL: <https://support.gt bicycles.com/hc/en-us/sections/1500000666522-Assembly>



STEP 9. Front Brake

Assembly, Adjustment

There are two basic types of brakes: (1) disc brakes, where you see a large shiny disc brake rotor. Some disc brakes are mechanically/cable actuated. Some disc brakes are hydraulically actuated, use brake fluid within tubing. (2) rim brakes, where the brakes act on the wheel rims. Some rim brakes have long arms and a linkage at the top of these arms. These are called V brakes or Linear Pull Brakes. Some rim brakes form an arch over the wheel, are typically seen on road bikes, these are called Caliper Brakes.

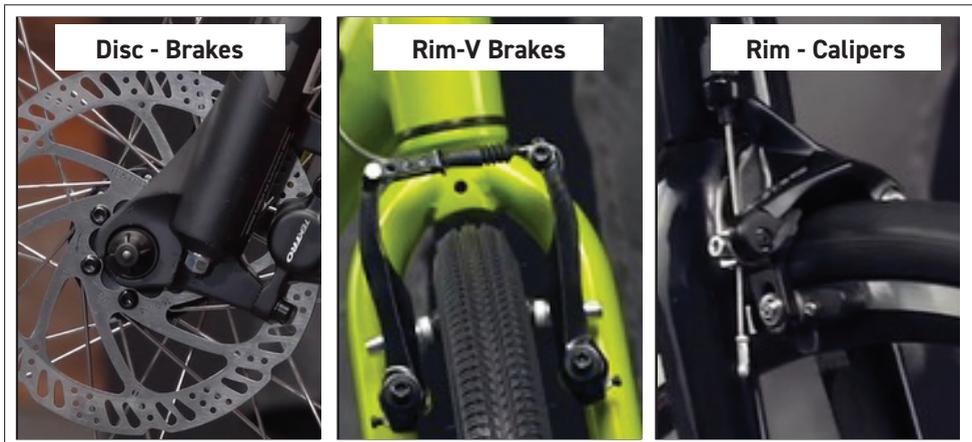

DISC - Mechanical

Cable Operated Disc Brakes:

Route the front brake cable and housing assembly from the left-hand brake lever down to the front brake caliper.

Thread the cable into the fitting on the front brake caliper, and then seat the end of the housing into the fitting on the front brake caliper. See photos on page ____ re proper seating of housings.

Find any cable housing fitting on the fork and secure the cable housing. This may be a small treaded fitting, such as a clamp with a 3mm screw, or a cable tie/zip tie. Securing the cable housing properly is an important safety step to keep it from interfering with the front wheel.

Now thread the cable into the cable anchor bolt fitting on the front brake caliper. You may need to open this fitting with a 5mm allen wrench.

Be sure that the brake arm is at it lowermost, retracted position. Note downward angle of brake arm in above drawing. Note significant gap between the brake arm and the caliper body, which allows the arm to move and the brakes to work. Keep the cable snug and confirm that the cable is captured by the cable anchor bolt fitting. Tighten this bolt with a 5mm allen wrench to 7 Nm.

The front brake cable provided is intentionally longer that it needs to be. After you have clamped the cable with the cable anchor bolt you will need to cut the cable. Cut the cable about 1 ½ " below this bolt.

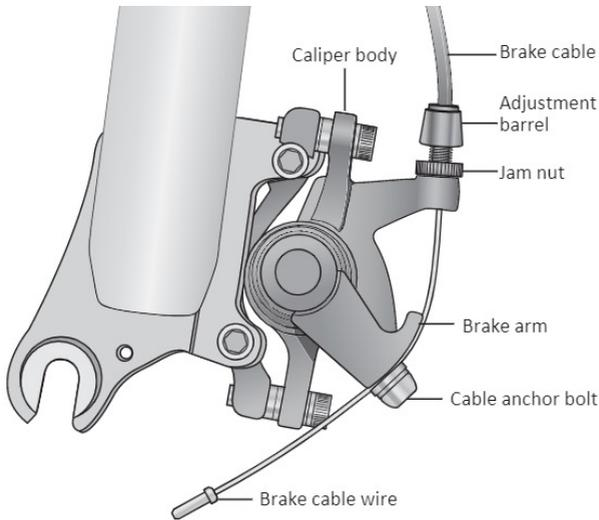

Next fit a cable end over the cut cable end. These cable ends are small soft aluminum caps that fit over the cable. Slide the cable end over the cable until it stops. Then crimp the cable end onto the cable. To crimp use pliers or the crimping part of the bicycle cable cutter to crimp the cable end in place. These cable ends are important for two reasons (1) They protect your hands and clothing from the sharp cut cable (2) They prevent the cable strands from separating, fraying.

Pro Tip: We urge you to borrow or buy a proper bicycle cable cutter. These tools have a v-shaped or circular jaws that keep the cable strands together as it cuts, resulting in a clean cut. Using conventional diagonal cutters will usually result in a frayed cable as the jaws force the cable strands apart.

The front brake is now connected but will almost certainly need adjustment.

Pick up the front of the bike and spin the front wheel. Do you see or hear dragging from the front brake? If yes, adjustment is needed.

See disc brake assembly adjustment videos at www.cannondale.com, Help Center, Owner Manuals & Assembly or www.gtbicycles.com, Support, Assembly. "

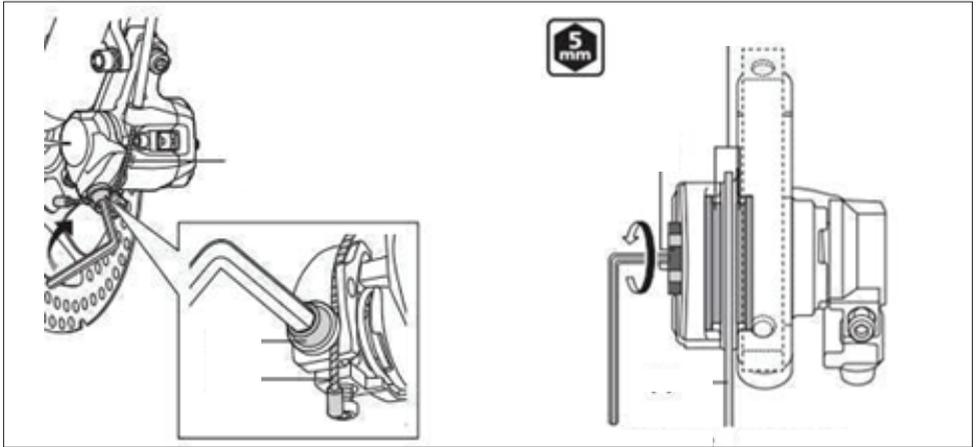

Locate and loosen the two caliper mounting bolts with a 5mm allen wrench. Loosen just enough to be able to move the caliper with your hand.

Lift the front of the bike and spin the front wheel and apply the front brake very firmly. Hold the front brake lever on very firmly with one hand, do not let go. With your other hand use a 5mm allen wrench to tighten the two caliper mounting bolts. No final torque at this point, just tight.

Again, pick up the front of the bike and spin the front wheel. Do you see or hear dragging from the front brake? Likely much less or no dragging.

If no drag, no noise, torque the two 5mm caliper mounting bolts to 7 Nm.

If there is some drag, some noise, again loosen the two caliper mounting bolts with the 5mm allen wrench. Loosen just enough to be able to move the caliper with your hand. Pick up the front of the bike and spin the front wheel. Apply the front brake very firmly. Hold the front brake lever on very firmly with one hand, do not let go. With your other hand use the 5mm allen wrench to tighten the two caliper mounting bolts. No final torque at this point, just tight. It is common for this process to take two or more operations to properly adjust the brake.

Again, pick up the front of the bike and spin the front wheel. Do you see or hear dragging from the front brake? If no drag, no noise, torque the two caliper mounting bolts to 7 Nm.

Mechanical disc brakes have one brake pad that is stationary. The other brake pad is pushed against the rotor.

Mechanical disc brakes have a 5mm brake pad adjustment screw that can be used to set the clearance between the stationary brake pad and the rotor. Look carefully at this clearance in the caliper as you turn the brake pad adjustment screw. Turning clockwise will reduce the clearance by moving the brake pad in. Turning the screw counter clockwise will increase clearance, eliminate drag, by moving the brake pad out. Your goal is to have clearance between the stationary brake pad and the rotor to be very close, but not drag.

DISC - Hydraulic

(no metal cable, instead plastic lines or tubes that contain brake fluid):

The hydraulic lines are already routed, connected and full of brake fluid. But you still need to adjust the position of the brake caliper.

 **WARNING**

Do not loosen or take apart any hydraulic brake line or fitting.

Pick up the front of the bike and spin the front wheel. Do you see or hear dragging from the front brake? If yes, adjustment is needed.

Locate and loosen the two caliper mounting bolts with the 5mm allen wrench. Loosen just enough to be able to move the caliper with your hand.

Lift the front of the bike and spin the front wheel and apply the front brake very firmly. Hold the front brake lever on very firmly with one hand, do not let go. With your other hand use a 5mm allen wrench to tighten the two caliper mounting bolts. No final torque at this point, just tight.

Again, pick up the front of the bike and spin the front wheel. Do you see or hear dragging from the front brake? Likely much less or no dragging.

If no drag, no noise, torque the two 5mm caliper mounting bolts to 7 Nm.

If there is some drag, some noise, again loosen the two caliper mounting bolts with the 5mm allen wrench. Loosen just enough to be able to move the caliper with your hand. Pick up the front of the bike and spin the front wheel. Apply the front brake very firmly. Hold the front brake lever on very firmly with one hand, do not let go. With your other hand use the 5mm allen wrench to tighten the two caliper mounting bolts. No final torque at this point, just tight. It is common for this process to take two or more operations to properly adjust the brake.

See video instruction at: <https://support.gtbicycles.com/hc/en-us/articles/1500008322681-Dick-s-Sporting-Goods-Avalanche-Assembly>

For all disc brakes:

Note that it may take anywhere from 20 to 40 complete stops to "break-in" your disk brakes. You may notice an increase in braking power after the first ride. Do not touch the disc brake rotors with your fingers or expose them to oils and lubricants. These contaminants will significantly degrade braking performance. Best practice is to clean the surfaces of the disc brake rotor with isopropyl alcohol.

**WARNING**

Do not touch or clean the rotor immediately after use, as the rotor may be very hot and could burn you.

V brakes, (also Linear Pull)

Use your hand to squeeze the two brake arms together, brake pads pressing firmly against the rim. Re attach the curved brake cable guide (often called a "noodle") to the bracket that holds it. The smaller diameter lower end of this curved cable guide fits into a slot in the bracket. The smaller diameter end, with the cable inside it, will protrude through the bracket. Slide the protective rubber boot over the smaller diameter end that is protruding through the bracket.

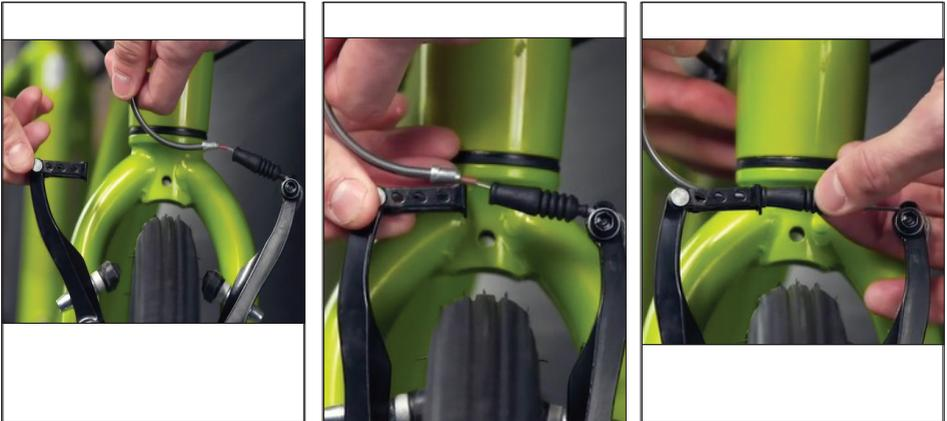

Caliper Brakes

Most common on road bikes:

Locate the front brake quick release lever on the brake caliper. This is the lever that opens and closes brake clearance to create tire clearance for wheel removal and installation. Move this lever down. You will see the caliper arms and brake pads move in.

Check brake function:

Stand over the bike with the saddle between your legs. Squeeze both brake levers as hard as possible about 10 times. The brake cables should not slip or become looser and the brake pads should not rotate. Roll the bike forward and apply the brakes, you should see and feel the brakes work to stop the bike.

The brake pads should fully contact the rim or brake rotor within 1 inch of brake lever movement. The brake lever must never bottom out or contact the handlebar or handlebar grip.

For caliper and linear pull type brakes, check that the brake pads contact the brake track of wheel rim squarely, making full contact with the brake track. Properly set up, the brake pads should be close to, but not touching the brake track of the rim. About 2mm clearance each side. No brake pad must ever make contact with the tire or be positioned below the brake track on the wheel rim. If you see incorrect alignment bring your bike to a professional bicycle mechanic.

**WARNING**

Brake set up is critical to your safety. If you discover a problem with your brakes, or if you have any question or concern you must get help before riding. See Contact Information in this manual or bring your bike to a professional bicycle mechanic.

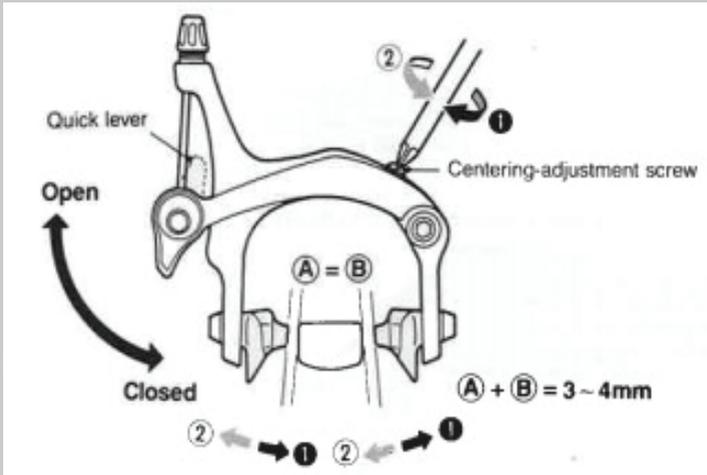
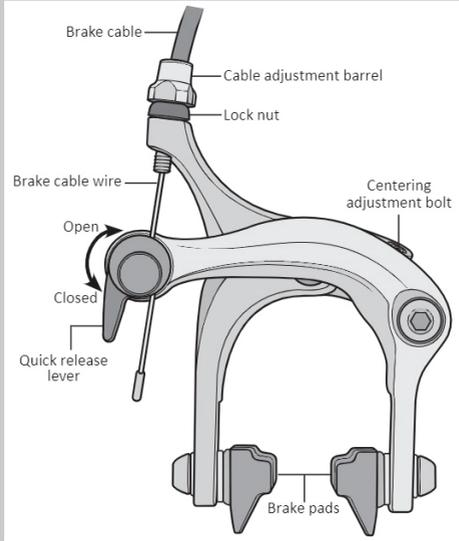

Correct alignment



Incorrect alignment



10. Install Pedals

Many bikes are sold without pedals, as riders have many choices and preferences for pedal and shoe systems. You may be installing the OEM pedals shipped with the bike or pedals you purchased separately. The procedure is the same. Read the instructions and warnings that come with any aftermarket pedals you purchase. Ask your retailer to give you these instructions and warnings.

CAUTION - Identify left and right pedals: There is a left pedal and a right pedal – they are not interchangeable, have different threading. Do Not force the wrong pedal into the wrong crank arm. Many crank arms have a removable sticker near the pedal threads, so you can match the left and right pedal threads.

Markings

The **RIGHT PEDAL** is identified with a “R” or “D” and has right-hand threads, meaning this pedal is tightened by “Righty-Tighty” or clockwise. These marks are found on the wrench flats near the threads or the end of the pedal spindle near the threads.

The **LEFT PEDAL** is identified with an “L” or “S” and has left-hand threads, meaning this pedal is tightened by turning to the left, counterclockwise. These marks are found on the wrench flats near the threads or the end of the pedal spindle near the threads.

Note: Left and right based on straddling the bike.

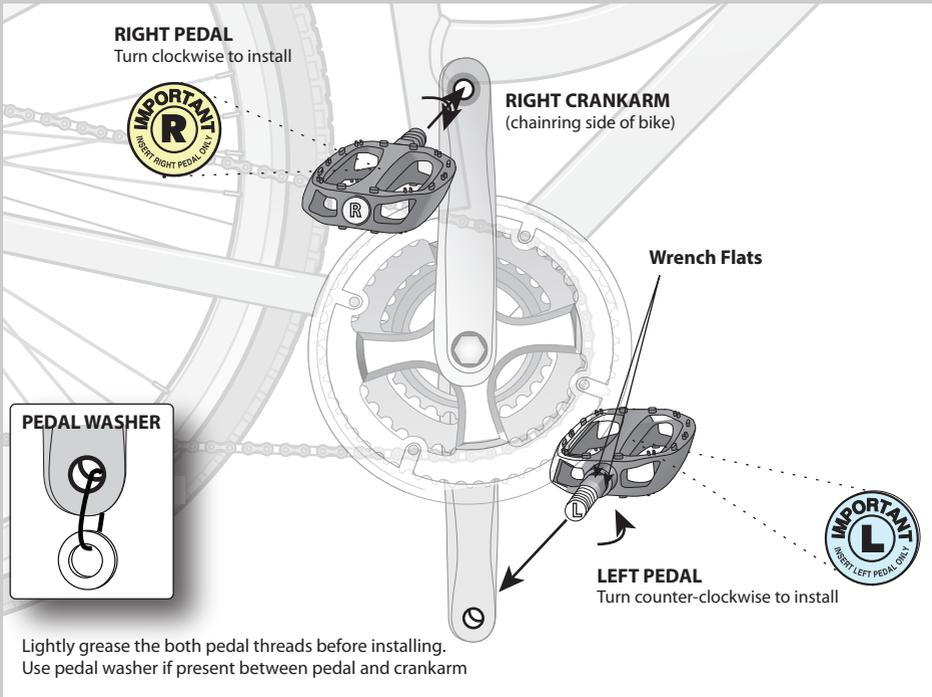

Installation

- If there are washers secured to the crank arm or shipped with the pedals, install one washer on each pedal axle prior to installation.
- Smear grease on each of the pedal threads. This is important to prevent corrosion.
- Standing on the left side of the bike (the side without the chain), take the threaded end of pedal marked "L" and align with threaded hole in crank arm and turn the wrench flats carefully, by hand, in a counter-clockwise direction (toward the front).
- Tighten securely with a pedal wrench or 15mm open end wrench. Make them very tight.
- Stand on the right side of the bike (side with the chain) take the threaded end of the pedal marked "R" and align with threaded hole in crank arm and turn the wrench flats carefully, by hand, in a turn clockwise (toward the front).
- Tighten securely with a pedal wrench or 15mm open end wrench. Make them very tight.

Pro Tip: We urge you to borrow or buy a proper pedal wrench. These wrenches are narrow to fit the narrow wrench flats on the pedal axles. These wrenches are long, to provide leverage to tighten and remove pedals.

 **WARNING**

Don't ride your bike without securely tightening both pedals.

11. Security Checks

Handlebar Security

Before riding the bike, test to determine whether the handlebars are secure:

- Stand facing the bike and straddle the front wheel.
- On a racing, drop-style bar - hold the brake-levers and slowly apply weight to until your feet lift off the floor. The handlebar should not move.
- On a flat handlebar - slowly apply body weight to handlebars (if installed, handlebar ends) until your feet lift off the floor. The handlebar (and bar-ends) should not move.
- With either design, if the handlebar slips, increase the torque to the upper torque value specified on the stem/bar and test again. DO NOT exceed upper limit of torque range.
- If the bars still move, contact your retailer or call 1-800- BIKEUSA for further assistance. DO NOT RIDE THE BIKE.

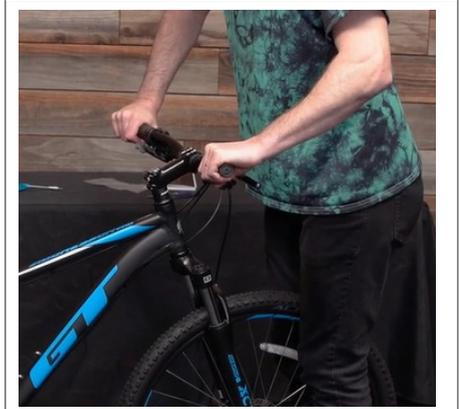

Figure. No Movement Test

Handlebar/ Stem Security

Before riding the bike, test to determine whether the handlebar stem is secure:

- Place the front wheel of the bike between your legs and strongly try to twist the handlebar/ stem assembly side-to-side with significant force (about 30-40 lbs.).
- If you can twist the handlebar stem relative to the front wheel, the stem bolts that clamp the stem to the fork are too loose. Tighten to the torque specified on the stem and test again. DO NOT exceed upper limit of torque range.
- If the stem still moves, contact your retailer or call 1-800- BIKEUSA for further assistance. DO NOT RIDE THE BIKE.



Figure. Handlebar Twist Test

Seat Post Security:

Before riding the bike, test to determine whether the seat and seat post are secure:

- Firmly grab the front of the seat and try hard to move it up and down, then side to side.
- If you can move the seat relative to the seat post, the bolt or bolts that clamp the seat to the top of the seat post are too loose. Tighten to the torque specified on the seat post or 7Nm and test again. DO NOT exceed upper limit of torque range.
- If you can move the seat post relative to the frame, the clamp bolt or seat post quick release is too loose. Tighten to the torque specified or 7Nm and test again. DO NOT exceed upper limit of torque range.
- If the seat or seat post still moves, contact your retailer or call 1-800- BIKEUSA for further assistance. DO NOT RIDE THE BIKE.



Figure. Seat Post Twist Test

STEP 12. MOUNTAIN BIKE

Component Set-Ups

Suspension fork:

Most mountain bikes are equipped with a suspension fork. For your safety and to optimize the performance of your suspension fork and bike, please find and read the separate suspension fork owner's manual included with your bicycle and/or available at:

- Fox forks www.ridefox.com go to BIKE, then TECH HELP
- Rockshox forks www.sram.com go to Rockshox, then SERVICE/SUPPORT
- SR Suntour forks www.srsuntour.us go to PRODUCT SUPPORT

Full suspension:

Some mountain bikes have full suspension, meaning front and rear suspension. If your bike has full suspension, see notes the above regarding the fork. For your safety and to optimize the performance of your bike, please find and read the separate model owner's manual supplement included with your bike and available on the website. These are expensive, sophisticated investments. You have invested in such a bike, and we urge you have it properly adjusted and set up and maintained by Authorized Dealer.

Full suspension:

Some mountain bikes have full suspension, meaning front and rear suspension. If your bike has full suspension, see notes the above regarding the fork. For your safety and to optimize the performance of your bike, please find and read the separate model owner's manual supplement included with your bike and available on the website. These are expensive, sophisticated investments. You have invested in such a bike, and we urge you have it properly adjusted and set up and maintained by Authorized Dealer.

Dropper seat posts:

Some mountain bikes come with cable actuated dropper seat posts that allow the rider to change seat height while riding. For your safety and to optimize the performance of your bike, please read the separate dropper seat post owner's manual or visit with your local retailer.

Assemble dropper seat post with the housing and cable long. The cable housing will already be run inside the frame tubes, sticking out and long. Once the saddle height has been established, excess housing is trimmed. You will then need to route the cable inside the housing, attach the cable and make cable tension adjustments.

STEP 13. Electric Bikes

Electric, or electric assist or "E-bikes" use most of the same standard bicycle components described in this assembly section, so assembly procedures are the same.

What makes them more complex, heavier and costlier is the electric drive train, battery and controls.

For your safety and to optimize the performance of your bike, please find and read the separate electric bike owner's manual supplement included with your bike and on the website.

This document is your source for information on the use of controls, safety considerations and warnings and the use and maintenance of electric drive train, battery. You have invested in such a bike, and we urge you have it properly adjusted and set up and maintained by your local retailer.

WARNING

E-Bikes are faster and heavier than regular bikes. Failure to assemble, adjust or ride correctly could lead to an accident, with risk of serious injury, paralysis or death.

Minimize these risks by:

1. Reading the electric bike owner's supplement and E-Bike information of Part 2 of this manual.
2. Getting an full bike orientation including the bike and the drive system from a professional at a local bike retailer.
3. Understanding that its easy to be surprised by the drive system and the power-assist capability. So learn to ride and become familiar with the E-Bike by riding slowly and carefully in a low hazard/low trafficked area.

STEP 14. Suspension Forks / Special Components

Suspension fork:

Many hybrid, trekking and Adventure bikes are equipped with a suspension fork. For your safety and to optimize the performance of your bike, please find and read the separate suspension fork owner's manual included with your bike.

Adjustable stem:

Some hybrid, trekking, Adventure and electric bikes are equipped with a stem that can be adjusted to change the angle of the stem. Please look carefully at any instructions on the stem. See the instructions below re a 50 mile tune up. This is an ideal time to fine tune your fit if you bike has an adjustable stem.

STEP 15. Final Inspections

Checklist

Before riding, please review this checklist:

Sit down, put your feet up and read the Owner's Manual and any Owner's Manual supplements.

Are wheel quick-release levers, through axles or nuts securely tightened? This is critical to your safety.

Is the handlebar/stem securely tightened (do the twist test again)?

Is the seatpost clamp bolt or quick-release clamping mechanism securely tightened?

Is the saddle clamp under the saddle at the top of the seatpost securely tightened?

Do the brakes have proper clearance and are they properly adjusted? Inspect and test them.

Are the pedals securely tightened to the crank arms?

Are your tires inflated to the correct pressure? This information is located on the tire's sidewall.

STEP 16. TEST RIDE & TUNE UPS

Importance the Test Ride

We urge you to take your new bike on **careful test rides** in a safe protected area in your neighborhood before riding in traffic or taking a longer ride on the road or trails. Before the first of these rides double check that the front wheel is properly attached to the fork. Use and buckle up your helmet.

Your goals are:

- Become familiar with how the brakes feel and work. Use the brakes, gently at first, then progressively harder. As described in the Owner's Manual, use caution and do not use the front brakes too hard.
- Shift through all the gears, up and down. Anticipate hills and shift before pedaling gets too hard. After shifting is complete, is the bike quiet in all gears?
- How do you fit on the bike? Is the seat too high or too low? As described in the Owner's Manual, you want your knees to be slightly bent at the bottom of each pedal stroke. Take short test rides, stop and adjust seat height. Once you have height dialed in, you may want to adjust seat angle.
- How do the controls and your hands and arms feel? The entire handlebar assembly including the brake and shifter levers can be easily rotated to where they feel comfortable and easy to reach. See the section in these instructions regarding the stem face plate.
- Next ride over some small bumps or rough pavement. Does the bike make any noises? Does anything feel loose? A well set up bike will be very quiet.

After First 50 Miles Tune Up

We urge you to schedule a professional check, tune up, with your local bike retailer when you have ridden the bike for about a month or about 50 miles. This is a lot like having the first service, first oil change on a new car. Parts wear in, brake and shifting cables settle in. This is an important time to have a professional service. This appointment is also a great time to ask any questions, fine tune your fit, and add accessories.

WARNING

Many aspects of mechanical work on a bike, including but not limited to correct installation of the front wheel, are critical to the safety of the rider. Failure to do so correctly could lead to an accident, with serious injury, paralysis or death.

If you have any questions or any doubts about any aspect of the assembly of this bike, including installation of the front wheel, **DO NOT RIDE THE BIKE**. Seek help from a professional bicycle mechanic at a local bike shop or retailer or call 1-800-BIKE-USA.

WARNING

As communicated at the beginning of this PART3 - Assembly instructions:

Failure to assemble and adjust your bike correctly could lead to an accident, with risk of serious injury, paralysis or death.

To minimize this risk, we encourage you to consider bringing your bike to a professional bicycle mechanic at a local bicycle retailer. Even if you choose to assemble the bike yourself, a professional bicycle mechanic can double-check the assembly and confirm your bike is ready for many miles of trouble-free riding.

Limited Warranty

GT stands behind all of its products.

GT bicycles are warranted against manufacturing defects in materials or workmanship. GT will repair or replace any products found to be defective within the normal scope of use with the same or most nearly comparable model or component then available. The terms of this limited warranty are described below.

Limited Warranty

Length Of Warranty

Every bicycle has a useful product lifespan. This limited warranty is not meant to suggest or imply that the frame or components can never be broken or will last forever. This limited warranty covers manufacturing defects that occur within the normal lifespan and use of the product.

GT bicycles must be registered on gtbicycles.com or in person by an Authorized GT Retailer in order to activate the lifetime frame warranty described below.

Frames, excluding those listed below: Lifetime of the original owner.

Frames of Gravity, Freeride, Downhill, Dirt Jump and other ASTM Category Five Bicycles: Three years from original retail purchase.

Swing Arms, Chainstays, Seatstays, and Shock Links of Full Suspension Frames: Five years from original retail purchase.

GT Branded Forks and Unbranded Forks: The fork structure is covered under the frame warranty. The internal components are covered as GT Branded Components.

GT Branded Components: One year from original retail purchase.

Non-GT Branded Components, including Non-GT Branded Forks, Electronic Systems, Shocks, and Other Components, are covered by the stated warranty, if any, of their manufacturer, and are not covered under this limited warranty. Please check in your owner's manual pack for information regarding these warranties.

Paint and Decals: One year from original retail purchase.

Warranty Conditions

This limited warranty applies only to the original owner of the bicycle and is not transferable to subsequent owners.

For any warranty claim to be considered, the bicycle must be brought in to an Authorized GT Retailer on the same continent on which the bicycle was purchased. The bicycle must be in an assembled, reasonably clean and sanitary condition and accompanied by the original, dated sales receipt for the bicycle (be sure to keep your receipt in a safe place!).

This limited warranty applies only to bicycles purchased in assembled and adjusted condition from Authorized GT Retailers.

This limited warranty is void if the bicycle is subjected to abuse, neglect, improper repair, improper assembly, lack of proper maintenance according to the owner's manual, alteration, modification, installation of incompatible parts, corrosion, an accident or other abnormal, excessive, or improper use.

This limited warranty is void if the bicycle is used in a rental or bike sharing program.

Damage resulting from normal wear and tear, including the results of fatigue, is not covered. It is the owner's responsibility to regularly inspect and properly maintain his/her bicycle. Some items that typically exhibit damage from normal wear and tear include:

Bearings	Cassettes	Seals	Wheel braking surface
Bearing races	Tires	Brake pads	Spokes
Rear shock mounting hardware and main seals	Tubes	Pawls	Handlebar and grips
Chainrings	Saddle	Free hubs	Cables and housing
	Chain		Bushings

Paint fading caused by the effects of ultraviolet light (UV) or outdoor exposure is not covered by this limited warranty.

All labor charges for warranty service, including the transfer of components and/or any installation of new components, are the responsibility of the bicycle owner.

Due to product evolution and obsolescence (such as products that have been discontinued or are no longer kept in stock), some frames or components may not be available for older models. In these cases, GT may elect to provide a replacement that it determines to be the most nearly comparable model, but sourcing and paying for components is the responsibility of the bicycle owner.

All determinations under this limited warranty will be made in the sole discretion of GT, including but not limited to the decision to repair or replace a defective product, and what replacement product is the most nearly comparable product then available.

THE REMEDIES STATED ABOVE ARE THE EXCLUSIVE REMEDIES UNDER THIS WARRANTY. ANY AND ALL OTHER REMEDIES AND DAMAGES THAT MAY OTHERWISE BE APPLICABLE ARE EXCLUDED, INCLUDING, BUT NOT LIMITED TO, INCIDENTAL OR CONSEQUENTIAL DAMAGES, DAMAGES TO OTHER PROPERTY, OR ANY PUNITIVE DAMAGES.

THIS IS THE ONLY WARRANTY MADE BY GT ON ITS FRAMES AND COMPONENTS, AND THERE ARE NO WARRANTIES WHICH EXTEND BEYOND THE DESCRIPTION HEREIN. ANY WARRANTIES THAT MAY OTHERWISE BE IMPLIED BY LAW INCLUDING, BUT NOT LIMITED TO, ANY IMPLIED WARRANTY OF MERCHANTABILITY OR FITNESS FOR A PARTICULAR PURPOSE, ARE EXCLUDED.

PLEASE REFER TO THE DOCUMENTS INCLUDED WITH YOUR BICYCLE FOR POSSIBLE FURTHER RESTRICTIONS.

THIS LIMITED WARRANTY GIVES THE CONSUMER SPECIFIC LEGAL RIGHTS. THE CONSUMER MAY ALSO HAVE OTHER LEGAL RIGHTS WHICH VARY FROM STATE TO STATE OR COUNTRY TO COUNTRY. SOME STATES AND COUNTRIES DO NOT ALLOW THE EXCLUSION OR LIMITATION OF INCIDENTAL OR CONSEQUENTIAL DAMAGES OR WARRANTIES, SO THE ABOVE LIMITATIONS OR EXCLUSIONS MAY NOT APPLY TO YOU. IF IT IS DETERMINED BY A COURT OF COMPETENT JURISDICTION THAT A CERTAIN PROVISION OF THIS LIMITED WARRANTY DOES NOT APPLY, SUCH DETERMINATION SHALL NOT AFFECT ANY OTHER PROVISION OF THIS LIMITED WARRANTY AND ALL OTHER PROVISIONS SHALL REMAIN IN EFFECT.

Pre-Ride Checklist

Are you wearing a helmet and other appropriate equipment and clothing, such as protective glasses and gloves? Do not wear loose clothing that could become entangled in the bicycle (See PART I, Section 2.A The Basics).

Are your seatpost and stem securely fastened? Twist the handlebars firmly from side to side while holding the front wheel between your knees. The stem must not move in the steering tube. Similarly, the seat post must be secure in the seat tube (See PART I, Section 3. Fit).

Are you visible to motorists? If you are riding at dusk, dawn or at night, you must make yourself visible to motorists. Use front and rear lights and a strobe or blinker. Reflectors alone do not provide adequate visibility. Wear reflective clothing (See PART I, Section 2.E Night Riding and PART II, A. Important Safety Information).

Is it raining or wet? If so, be more cautious. Your braking distances will increase, and your tires' grip on the road will decrease. Remember that motorists' visibility decreases with bad weather (See PART I, Section 2.D Wet Weather Riding and PART II, A. Important Safety Information).

Are your tires properly inflated? Tires must be inflated to the recommended pressure. (See PART I, Section 4.G Tires and Tubes).

Are your wheels true? Lift each end of the bike and spin each wheel. Does the space between the rim and the brake pads, or the tire and the frame, remain nearly the same size as the wheel turns? Are your spokes tight? (See PART I, Section 1.C Mechanical Safety Check).

Are your wheels' quick-releases properly fastened? Be sure to read the section on proper operation of quick-release skewers (See PART I, Section 4.A Wheels).

Are your front and rear brakes functioning properly? With V-brakes, the quick release "noodle" must be properly installed. With cantilever brakes, the quick release straddle cable must be properly attached. With caliper brakes the quick release lever must be closed. With any rim brake, the brake pads must make firm contact with the rim without the brake levers hitting the handlebar grip (See PART I, Section 4.C Brakes).

With hydraulic disc brakes, check that the lever feels firm, does not move too close to the handlebar grip, and there is no evidence of leaking brake fluid. With cable actuated disc brakes, check that the lever feels firm and does not move too close to the handlebar grip. With any disc brakes, the brake pads must make firm contact with the rotor without the brake levers hitting the handlebar grip (See PART I, Section 4.C Brakes).

How do your clipless pedals work today? Clip in and out of your pedals before you begin. Experienced cyclists do. The connection between cleat and pedal is affected by dozens of factors including dirt, mud, lubrication, spring tension and wear. By clipping in and out you will check the function and have a fresh memory of how they feel (See PART I, Section 4.E Pedals).

How recently were your frame, fork and components inspected? Never ride a frame, fork or components with any crack or damage. (See PART II, Section D. Inspect For Safety).

WARNING

FOLLOW THIS CHECKLIST BEFORE EVERY RIDE. IF YOU HAVE ANY REASON TO SUSPECT THAT YOUR BICYCLE IS NOT FUNCTIONING PROPERLY, DO NOT RIDE IT. Have it inspected by an Authorized GT Retailer. To locate your nearest Authorized GT Retailer call the 1-800-BIKE-USA. Failure to follow this checklist and to have any potential problem inspected could lead to an accident, with risk of serious injury, paralysis or death.